

... Precision is our Job!

TUSA[®]

Precision Tools SA



SWISS MADE



... Precision is our Job!

 L'attività industriale di TUSA Precision Tools SA consiste nello sviluppo e nella produzione di una vasta gamma di utensili da taglio in metallo duro di altissima qualità (carburo di tungsteno) come punte, micropunte, frese, microfresse, alesatori.

Il marchio TUSA Precision Tools, sul mercato da 50 anni, è una realtà affermata e conosciuta su scala mondiale ed è sinonimo di professionalità e alto livello qualitativo sia per quanto riguarda la realizzazione del prodotto che per il servizio fornito ai Clienti.

Tipiche applicazioni dei prodotti TUSA sono gli utensili per le lavorazioni meccaniche di alta precisione per i settori aerospaziale, medicale, ottico, gioielleria e orologeria, industria dei componenti elettronici, automotive ecc.

TUSA Precision Tools, grazie all'acquisto di attrezzature e macchinari all'avanguardia, è in grado di offrire alla propria clientela una gamma completa di utensili in metallo duro integrale in grado di rispondere al meglio alle attuali esigenze imposte dalle più avanzate tecniche produttive.

Lo staff tecnico di TUSA Precision Tools è in grado di garantire soluzioni ottimali di taglio per tutte le operazioni di lavorazione meccanica ed assicura assistenza tecnica e consulenza attiva ai partner commerciali.

La struttura organizzativa di TUSA Precision Tools è configurata al fine di assicurare ai Clienti massima flessibilità e tempistiche ottimizzate: soluzioni speciali possono essere realizzate in tempi brevi anche per lotti minimi.

 Die industrielle Tätigkeit der TUSA Precision Tools SA besteht in die Entwicklung und Produktion einer breiten Palette von Hochwertigen Schneidwerkzeugen aus Hartmetall wie Spiralbohrer, Micro-Spiralbohrer, Fräser und Reibahlen.

Die Marke TUSA ist weltweit bestens bekannt und steht für die Herstellung und Lieferung von qualitativ hochstehenden Produkten aus Vollhartmetall (Tungsten) wie auch für einen professionellen Kundenservice.

TUSA kann mit Stolz auf eine 50-jährige Erfahrung und das dadurch gewonnene Know-how im Hartmetallbereich zurückblicken.

TUSA Produkte sind Spezialwerkzeuge für Anwendungen aller Art im mechanischen Bereich, speziell auch für Hochgeschwindigkeits-Bearbeitungen in der Industrie wie z.B. im Flugzeug- und Autobau, in der Medizintechnologie, in der Optik-, Uhren-, Schmuck-Industrie sowie auch elektronischen und mechanischen Bereichen.

TUSA kann dank neuesten Technologien und Maschinen seinen Kunden eine komplette Palette von Hartmetall-Werkzeugen anbieten, die allen Anforderungen in der heutigen fortgeschrittenen Technik entsprechen.

Die technischen Spezialisten von TUSA garantieren für optimale Lösungen in allen Bereichen der mechanischen Bearbeitung und stehen unseren Kunden und Partnern mit aktiver Beratung jederzeit zur Verfügung.

Die Organisationsstruktur von TUSA gewährleistet auch die Realisierung und Fertigung von Spezialwerkzeugen gemäss Ihrem Bedarf durch optimale Flexibilität in kürzester Zeit, dies auch für kleinere Serien.

 The industrial activity of TUSA Precision Tools SA consists in the development and production of high-quality solid carbide (tungsten carbide) metal-cutting tools, such as drills, endmills, reamers. TUSA Precision Tools brand is well-known and recognized worldwide for 50 years as being synonymous with quality and professionalism, both in terms of production and of customer care. TUSA is proud of its 40 years' experience in the field of integral tungsten carbide tools. TUSA products are typically used for high-precision mechanical applications in the following fields: aerospace industry, medical supplies, optics, jewellery, watch making industry, electronic components industry, automotive and so on.

Thanks to the purchase of new modern equipment and machineries, TUSA can offer its customers a complete range of integral solid carbide tools that can meet the present requirements of the most advanced production techniques.

The TUSA Precision Tools engineering staff can guarantee the most effective metal cutting solutions for all mechanical operations and provide technical assistance and working advice to their business partners.

The company organization of TUSA Precision Tools is such that its customers can be assured of maximum flexibility and optimized timing: special design solutions can be achieved within short time periods, even for minimum lots.

Condizioni generali di vendita:

Per ogni ordine ricevuto sono valide esclusivamente le condizioni sottostanti. Condizioni diverse devono essere concordate e firmate da ambo le parti.

- In mancanza di accordi specifici, in riferimento alla clausola Incoterms 2010, tutti i prezzi sono da ritenersi: IVA esclusa, imballo escluso, costi di trasporto esclusi, tasse doganali ed altre eventuali escluse.
- In mancanza di accordi specifici, in riferimento alla clausola Incoterms 2010, per i termini di consegna fa fede esclusivamente la conferma d'ordine, e qualora la data di consegna dovesse subire ritardo, la mancata evasione dell'ordine nei termini stabiliti non da comunque nessun diritto all'annullamento dell'ordine o ad eventuali risarcimenti danni.
- Relativamente agli utensili speciali ci riserviamo il diritto di consegnare +/-10% rispetto alla quantità ordinata; la fatturazione comunque si basa sulla quantità effettivamente consegnata e sul prezzo del singolo pezzo come stabilito in fase di conferma d'ordine.
- Salvo accordi diversi l'imballo e il trasporto sono a carico e rischio del cliente.
- Se non vengono concordati termini diversi il pagamento deve avvenire a 30 giorni data fattura.
- Modifiche costruttive su articoli già realizzati in precedenza possono comportare costi aggiuntivi e in ogni caso devono pervenire per iscritto prima della realizzazione degli utensili. In caso contrario verrà utilizzato l'ultimo disegno fornito.
- I reclami devono pervenire per iscritto entro 10 giorni dalla consegna della merce. La sostituzione o il rimborso di pezzi difettosi sarà decisione del produttore solo dopo aver visionato il difetto. Tutta la merce non conforme dovrà essere restituita a Tusa Precision Tools SA, non verranno presi in considerazione reclami senza la merce in restituzione.
- Per ogni controversia è applicabile esclusivamente il codice delle obbligazioni svizzero ed il foro competente è in via esclusiva quella di Tusa Precision Tools SA.

General Sales Conditions:

We provide our deliveries and services exclusively in accordance with the following General Sales Conditions. Different conditions shall be agreed and subscribed by both parties.

- Unless specified or agreed, with reference to Incoterms 2010 clause, all prices shall be considered EXCLUDED from: VAT, packaging, freight costs, customs costs and other eventual costs.
- Unless specified or agreed, with reference to Incoterms 2010 clause, only terms and conditions expressly indicated in the order confirmation shall be considered valid; by the way delays in delivery of the goods do not grant in any case the right to cancel an order or to ask for a refund.
- For internal processing reasons, delivered quantities of special items can vary by max. +/- 10%. Invoicing is based upon the effectively delivered quantity and price respects the conditions stated in the order confirmation.
- Forwarding costs and packaging are chargeable to the customer and at his own risk.
- If not differently and expressly agreed, standard payment term is 30 days net.
- The request of modifications on already produced articles might affect price by involving higher/additional costs. Those requests shall be forwarded in written form and promptly. Otherwise production shall be based on the last supplied drawing.
- Complaints shall be forwarded within 10 days after receiving the goods. Replacement or refunds of defective articles shall be exclusively up to the supplier after checking the goods. All defective items shall be returned to Tusa Precision Tools SA. Otherwise complaints shall not be taken into consideration; anyhow before returning the goods the customer shall inform Tusa Precision Tools SA about it in written form.
- The court of Tusa Precision Tools SA shall have exclusive jurisdiction over any disputes relating to the terms and conditions mentioned above and only the Swiss Law shall be applied to any controversies.

Significato dei simboli Signification des symboles Symbole

Icons

マークの見方
符号

SMG
10

Metallo duro micrograna
Carbure micro-grain
Feinkorn Hartmetall
Micro grain Carbide
超微粒子超硬合金
超微粒硬质合金

TUSA
NORM

Norme TUSA
Normes TUSA
TUSA-Normung
TUSA norm
TUSA規格品
TUSA 标准



Geometria della testa
Géométrie de la tête
Kopfgeometrie
Head geometry
刃先形状
刀头几何形状



Lunghezza della serie
Longueur de série
Baulänge
Series length
長さ
系列长度

Z
2

N° denti
N° dents
Zähnezahl
N° of teeth
刃先枚数
N° 刀刃数



Senso di lavorazione possibile
Sens d'usinage possible
Mögliche Bearbeitungsrichtung
Machining direction possibility
加工方向
可机械加工的方向



Angolo di punta
Angle de pointe
Spitzenwinkel
Point angle
先端角度
顶角

RH

Taglio destro
Coupe à droite
Rechtsschneidend
Right hand cutting
右刃
右旋



Tagliante al centro
Coupe au centre
Zentrumschnitt
Center cutting
センターカットタイプ
中心切割



Angolo dell'elica
Angle d'hélice
Spiralwinkel
Flute angle
ねじれ角
刃角

MICRO

Micropunta
Micro-foret
Mikrobohrer
Micro drill
マイクロドリル
微钻头



Gambo cilindrico
Queue cylindrique
Zylindrisches Schaft
Cylindrical shank
筒形状シャンク
圆柱型加强柄

DIN
338

Norme DIN
Normes DIN
DIN-Normung
DIN Norm
DIN規格品
德国工业标准 DIN

3xD

Profondità di foratura
Profondeur de perçage
Bohrungstiefe
Depth of drilling
加工深さ
钻削深度

HSC

Alta velocità (HSC)
Haute vitesse (UGV)
Hochgeschwindigkeit (HSC)
High speed cutting (HSC)
高速加工速度用
高速切割

TUSA[®]
Precision Tools SA

CERAMIC



MICROUTENSILI
MICRO TOOLS







SWISS MADE

MSC40

Microfresa elicoidale, taglio al centro
Micro-fraise hélicoidale, coupe au centre
Mikrofräser, spiralgenutet, mit Zentrumschnitt
Micro-end mill, center cutting

精密超硬マイクロエンドミル、センターカット
 微立铣刀，中心切割

MSC 40

CERAMIC	Z 1 - 2 - 3
TUSA NORM	MICRO
	
	
	N

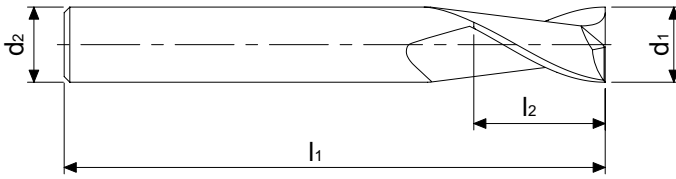

Campo d'impiego / Champ d'application / Einsatzbereich / Application field / 応用範囲 / 应用

HRC < 48	Ottone Brass	Rame Copper	ALU
----------	-----------------	----------------	-----

d1 h9	d2 h6	l1	l2	z	d1 h9	d2 h6	l1	l2	z
0,25	3,00	38	0,6	1	2,00	4,00	38	4	3
0,50	3,00	38	1	2	2,50	4,00	38	5	3
0,75	3,00	38	1,6	2	3,00	6,00	50	5	3
1,00	3,00	38	2	2	4,00	6,00	50	6	3
1,25	4,00	38	2,5	2	5,00	6,00	50	7	3
1,50	4,00	38	3	2	6,00	6,00	50	8	3
1,75	4,00	38	3,5	2					

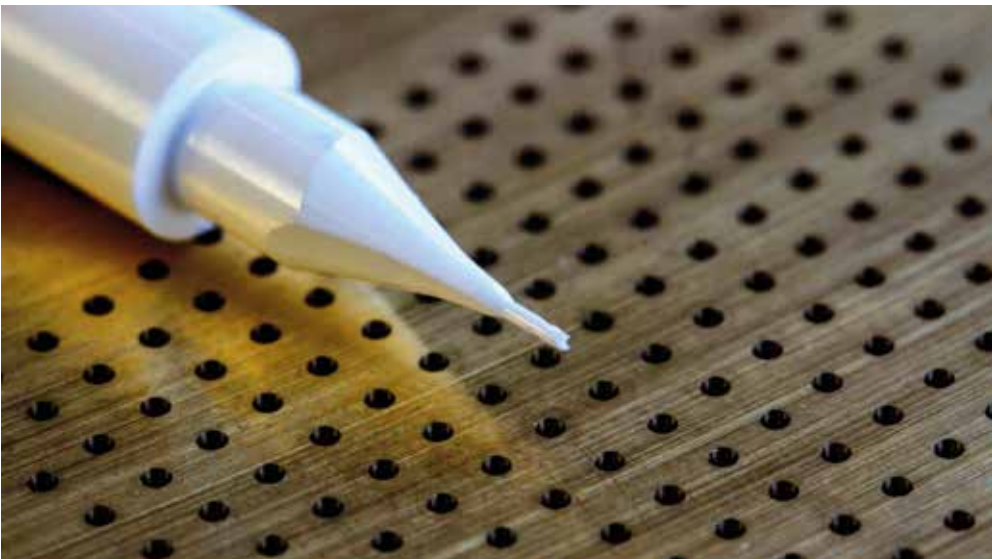

Example Interpolation milling of microborings:

Tusa Precision Tools SA has reached new dimensions with the ceramic high-precision milling cutter for micro-drilling. With the ceramic cutter it is possible to interpolate micro-precision bores with a up to 20-fold service life instead of rubbing.

The pictures below show the comparison between carbide endmills and ceramic endmills:

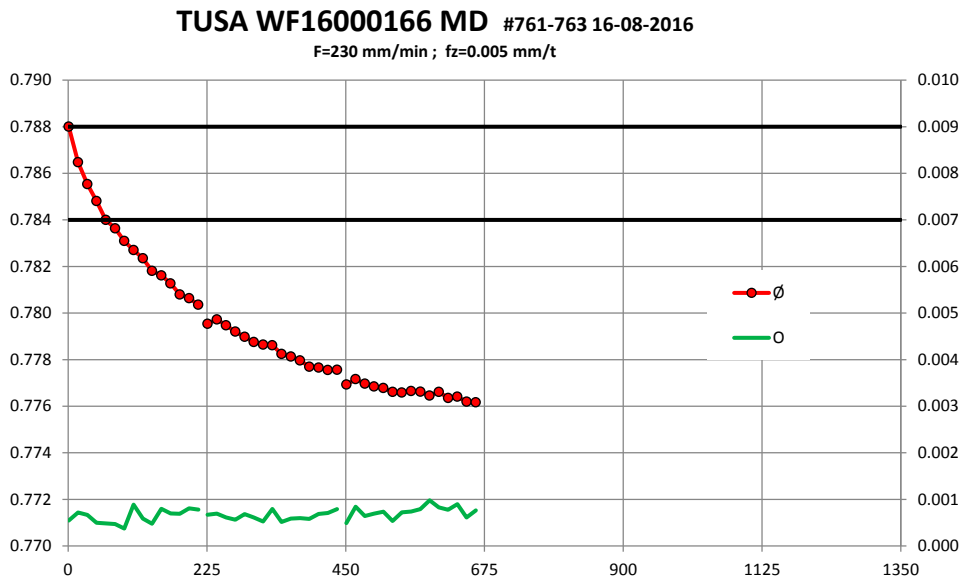

Here it is easy to see how, due to the wear of the hard metal drill after about 100 drillings, the bore diameter will migrate from the 4 μ tolerance field.

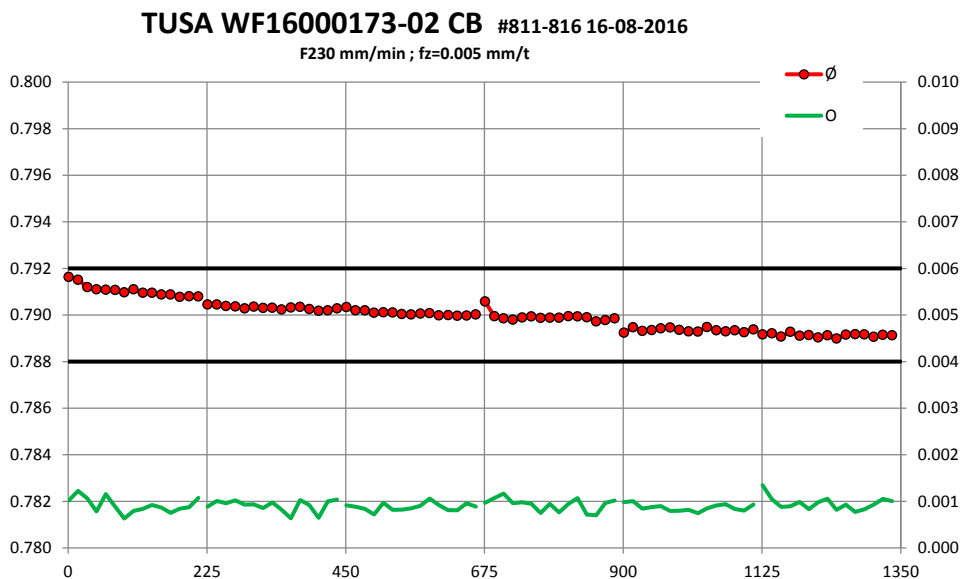

After 1350 holes, the ceramic milling cutter still shows a constant drilling pattern in the 4 μ tolerance field. After more than 1350 drillings the ceramic cutter does not have any appreciable cutting edge wear. In this experiment the 20-fold lifetime was significantly exceeded.

TUSA[®]

Precision Tools SA



PUNTE SERIE CORTE
SHORT SERIES DRILLS

MTB 25
MTB 25/1.100
MTB 25/3
MTB 30

 **SWISS MADE**

Punta elicoidale taglio destro
Foret hélicoidal coupe à droite
Spiralbohrer Rechtsschneidend
Twist drill right hand cutting

超硬ソリッドドリル
 右旋螺旋钻

MTB 25

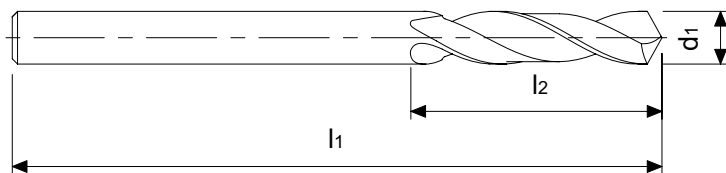

Campo d'impiego / Champ d'application / Einsatzbereich / Application field / 応用範囲 / 应用

HRC < 42	Inox Stainless	GG(G) / ghisa Ft / cast iron	Titanio Titan	ALU
----------	-------------------	---------------------------------	------------------	-----

d1	h6	l1	l2	d1	h6	l1	l2	d1	h6	l1	l2
0,50		20	3	4,20		55	22	8,00		79	37
0,60		21	4	4,30		58	24	8,10		79	37
0,70		23	5	4,40		58	24	8,20		79	37
0,80		24	5	4,50		58	24	8,30		79	37
0,90		25	6	4,60		58	24	8,40		79	37
1,00		26	6	4,70		58	24	8,50		79	37
1,10		28	7	4,80		62	26	8,60		84	40
1,20		30	8	4,90		62	26	8,70		84	40
1,30		30	8	5,00		62	26	8,80		84	40
1,40		32	9	5,10		62	26	8,90		84	40
1,50		32	9	5,20		62	26	9,00		84	40
1,60		34	10	5,30		62	26	9,10		84	40
1,70		34	10	5,40		66	28	9,20		84	40
1,80		36	11	5,50		66	28	9,30		84	40
1,90		36	11	5,60		66	28	9,40		84	40
2,00		38	12	5,70		66	28	9,50		84	40
2,10		38	12	5,80		66	28	9,60		89	43
2,20		40	13	5,90		66	28	9,70		89	43
2,30		40	13	6,00		66	28	9,80		89	43
2,40		43	14	6,10		70	31	9,90		89	43
2,50		43	14	6,20		70	31	10,00		89	43
2,60		43	14	6,30		70	31	10,10		89	43
2,70		46	16	6,40		70	31	10,20		89	43
2,80		46	16	6,50		70	31	10,50		89	43
2,90		46	16	6,60		70	31	11,00		95	47
3,00		46	16	6,70		70	31	11,50		95	47
3,10		49	18	6,80		74	34	11,80		95	47
3,20		49	18	6,90		74	34	12,00		102	51
3,30		49	18	7,00		74	34	12,50		102	51 *
3,40		52	20	7,10		74	34	12,70		102	51 *
3,50		52	20	7,20		74	34	13,00		102	51 *
3,60		52	20	7,30		74	34	13,50		102	51 *
3,70		52	20	7,40		74	34	14,00		107	54 *
3,80		55	22	7,50		74	34	14,50		107	56 *
3,90		55	22	7,60		79	37	15,00		111	56 *
4,00		55	22	7,70		79	37	16,00		115	58 *
4,10		55	22	7,80		79	37	18,00		123	62 *
				7,90		79	37	20,00		131	66 *

Disponibili su richiesta*
 Min. 5 pz

Disponible sur demande*
 Au moins 5 pièces

Available on request*
 Minimum qty 5 pcs

Verfügbar auf Anfrage*
 Mindestmenge 5 Stk

Punta elicoidale a 3 eliche, taglio destro
Foret hélicoidal à 3 lèvres, coupe à droite
3-Schneiden Spiralbohrer, Rechtsschneidend
3-fluted twist drill, right hand cutting

超硬ソリッドドリル3枚刃
 三刃右螺旋钻头

MTB 25/3

SMG 10	Z 3
DIN 6539	RH
	
	
	

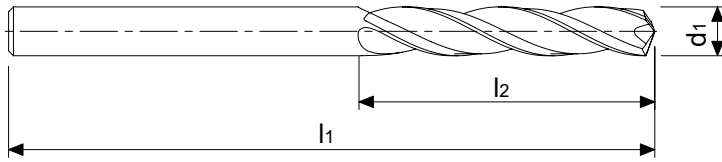

Campo d'impiego / Champ d'application / Einsatzbereich / Application field / 応用範囲 / 应用

HRC < 48	Inox Stainless	GG(G) / ghisa Ft / cast iron	Titanio Titan	ALU
----------	-------------------	---------------------------------	------------------	------------

d_1	h_8	l_1	l_2	d_1	h_8	l_1	l_2	d_1	h_8	l_1	l_2
3,00		46	16	4,90		62	26	10,00		89	43
3,10		49	18	5,00		62	26	10,50		89	43
3,20		49	18	5,10		62	26	11,00		95	47
3,30		49	18	5,20		62	26	11,50		95	47
3,40		52	20	5,30		62	26	12,00		102	51
3,50		52	20	5,40		66	28	12,50		102	51
3,60		52	20	5,50		66	28	13,50		107	54
3,70		52	20	5,60		66	28	14,00		107	54
3,80		55	22	5,70		66	28	14,50		111	56
3,90		55	22	5,80		66	28	15,00		111	56
4,00		55	22	5,90		66	28	15,50		115	58
4,10		55	22	6,00		66	28	16,00		115	58
4,20		55	22	6,50		70	31	16,50		119	60
4,30		58	24	7,00		74	34	17,00		119	60
4,40		58	24	7,50		74	34	17,50		123	62
4,50		58	24	8,00		79	37	18,00		123	62
4,60		58	24	8,50		79	37	18,50		127	64
4,70		58	24	9,00		84	40	19,00		127	64
4,80		62	26	9,50		84	40	19,50		131	66
								20,00		131	66

Disponibili su richiesta*
 Min. 5 pz

Disponible sur demande*
 Au moins 5 pièces

Available on request*
 Minimum qty 5 pcs

Verfügbar auf Anfrage*
 Mindestmenge 5 Stk

Punta elicoidale taglio destro
Foret hélicoidal coupe à droite
Spiralbohrer Rechtsschneidend
Twist drill right hand cutting

超硬ソリッドドリル
 右旋螺旋钻

MTB 25/1.100

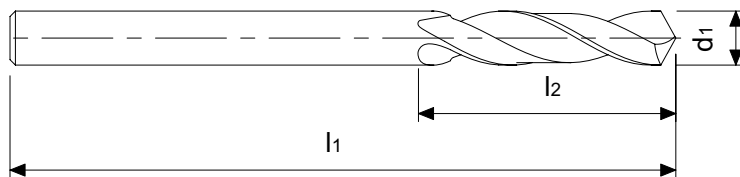

Campo d'impiego / Champ d'application / Einsatzbereich / Application field / 応用範囲 / 应用

HRC < 42	Inox Stainless	GG(G) / ghisa Ft / cast iron	Titanio Titan	ALU
--------------------	---------------------------	---	--------------------------	------------

d1 h6	l1	l2	d1 h6	l1	l2	d1 h6	l1	l2
0,30 - 0,39	30	4	3,50	50	25	5,35	65	40
0,40 - 0,49	30	5	3,55	50	25	5,40	65	40
0,50 - 0,59	30	6	3,60	55	27	5,45	65	40
0,60 - 0,69	30	6	3,65	55	27	5,50	65	40
0,70 - 0,79	40	12	3,70	55	27	5,55	65	40
0,80 - 0,89	40	12	3,75	55	27	5,60	65	40
0,90 - 0,99	40	12	3,80	55	27	5,65	65	40
1,00 - 1,09	40	15	3,85	55	27	5,70	65	40
1,10 - 1,19	40	15	3,90	55	27	5,75	65	40
1,20 - 1,29	40	15	3,95	55	27	5,80	65	40
1,30 - 1,39	40	16	4,00	55	27	5,85	65	40
1,40 - 1,49	40	16	4,05	55	27	5,90	65	40
1,50 - 1,59	40	16	4,10	60	30	5,95	65	40
1,60 - 1,69	40	18	4,15	60	30	6,00	65	40
1,70 - 1,79	40	18	4,20	60	30	6,10	65	40
1,80 - 1,89	40	18	4,25	60	30	6,20	65	40
1,90 - 1,99	40	18	4,30	60	30	6,30	65	40
2,00 - 2,09	40	18	4,35	60	30	6,40	65	40
2,10 - 2,19	40	20	4,40	60	30	6,50	65	40
2,20 - 2,29	40	20	4,45	60	30	6,60	65	40
2,30 - 2,39	40	20	4,50	60	30	6,70	65	40
2,40 - 2,49	40	20	4,55	60	30	6,80	65	40
2,50 - 2,59	40	20	4,60	60	30	6,90	65	40
2,60 - 2,69	45	20	4,65	60	30	7,00	65	40
2,70 - 2,79	45	20	4,70	60	30	7,20	80	40
2,80 - 2,89	45	20	4,75	60	30	7,50	80	40
2,90 - 2,99	45	20	4,80	60	30	8,00	80	40
3,00	45	20	4,85	60	30	8,50	80	40
3,05	45	20	4,90	60	30	9,00	80	40
3,10	50	25	4,95	60	30	9,50	80	40
3,15	50	25	5,00	60	30	10,00	100	50
3,20	50	25	5,05	60	30	10,50	100	50
3,25	50	25	5,10	65	40	11,00	100	50
3,30	50	25	5,15	65	40	11,50	100	50
3,35	50	25	5,20	65	40	12,00	100	50
3,40	50	25	5,25	65	40	12,50	100	50
3,45	50	25	5,30	65	40	13,00	100	50

Punta elicoidale taglio destro
Foret hélicoidal coupe à droite
Spiralbohrer Rechtsschneidend
Twist drill right hand cutting
 超硬ソリッドドリル
 右旋螺旋钻

MTB 30

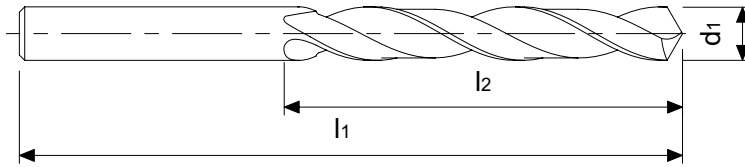

Campo d'impiego / Champ d'application / Einsatzbereich / Application field / 応用範囲 / 应用

HRC < 42	Inox Stainless	GG(G) / ghis Ft / cast iron	Titanio Titan	ALU
--------------------	---------------------------	--	--------------------------	------------

d1 h6	l1	l2	d1 h6	l1	l2	d1 h6	l1	l2
0,80	30	10	3,10	65	36	5,40	93	57
0,90	32	11	3,20	65	36	5,50	93	57
1,00	34	12	3,30	65	36	5,60	93	57
1,10	36	14	3,40	70	39	5,70	93	57
1,20	38	16	3,50	70	39	5,80	93	57
1,30	38	16	3,60	70	39	5,90	93	57
1,40	40	18	3,70	70	39	6,00	93	57
1,50	40	18	3,80	75	43	6,50	101	63
1,60	43	20	3,90	75	43	7,00	109	69
1,70	43	20	4,00	75	43	7,50	109	69
1,80	46	22	4,10	75	43	8,00	117	75
1,90	46	22	4,20	75	43	8,50	117	75
2,00	49	24	4,30	80	47	9,00	125	81
2,10	49	24	4,40	80	47	9,50	125	81
2,20	53	27	4,50	80	47	10,00	133	87
2,30	53	27	4,60	80	47	10,50	133	87
2,40	57	30	4,70	80	47	11,00	142	94
2,50	57	30	4,80	86	52	11,50	142	94
2,60	57	30	4,90	86	52	12,00	151	101
2,70	61	33	5,00	86	52	12,50	151	101 *
2,80	61	33	5,10	86	52	13,00	151	101 *
2,90	61	33	5,20	86	52	14,00	160	108 *
3,00	61	33	5,30	86	52	15,00	160	114 *
						16,00	160	120 *

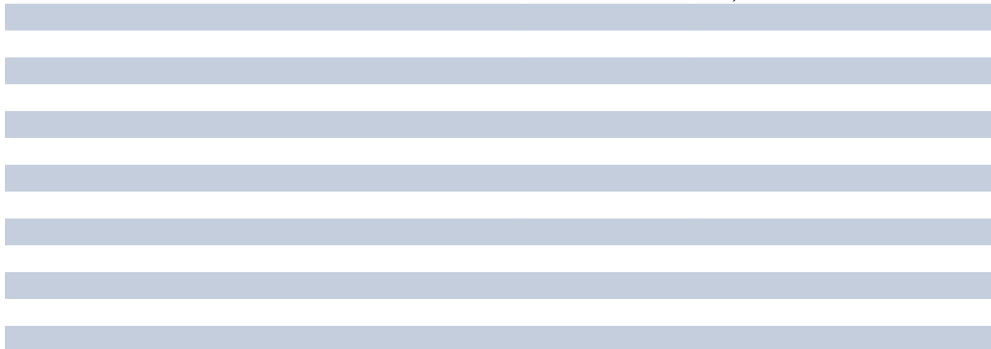

Disponibili su richiesta*
Min. 5 pz

Disponible sur demande*
Au moins 5 pièces

Available on request*
Minimum qty 5 pcs

Verfügbar auf Anfrage*
Mindestmenge 5 Stk



PUNTE

SEMI-DECIMALI - SINISTRE - DA CENTRO

DRILLS

HALF DECIMAL - LEFT - CENTER DRILLS

MTB 33

MTB 35

MTB 35/L

MTB 40

MTB 41



SWISS MADE

Punta elicoidale taglio destro
Foret hélicoidal coupe à droite
Spiralbohrer Rechtsschneidend
Twist drill right hand cutting

超硬ソリッドドリル
 右旋螺旋钻

MTB 33

SMG
10

Z
2

DIN
6539

RH

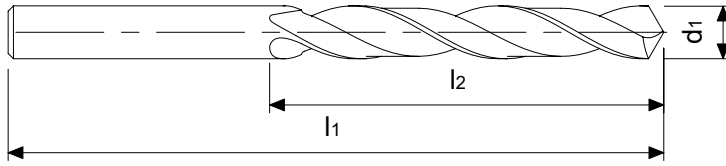

Campo d'impiego / Champ d'application / Einsatzbereich / Application field / 応用範囲 / 应用

HRC < 42

Inox
Stainless

GG(G) / ghisa
Ft / cast iron

Titanio
Titan

ALU

d1 h6	l1	l2	d1 h6	l1	l2	d1 h6	l1	l2
1,00	26	6	1,95	38	12	2,90	46	16
1,05	26	6	2,00	38	12	2,95	46	16
1,10	28	7	2,05	38	12	3,00	46	16
1,15	28	7	2,10	38	12	3,50	52	20
1,20	30	8	2,15	40	13	4,00	55	22
1,25	30	8	2,20	40	13	4,50	58	24
1,30	30	8	2,25	40	13	5,00	62	26
1,35	32	9	2,30	40	13	5,50	66	28
1,40	32	9	2,35	40	13	6,00	70	28
1,45	32	9	2,40	43	14	6,50	70	31
1,50	32	9	2,45	43	14	7,00	74	34
1,55	34	10	2,50	43	14	7,50	74	34
1,60	34	10	2,55	43	14	8,00	79	37
1,65	34	10	2,60	43	14	8,50	79	37
1,70	34	10	2,65	43	14	9,00	84	40
1,75	36	11	2,70	46	16	9,50	84	40
1,80	36	11	2,75	46	16	10,00	89	43
1,85	36	11	2,80	46	16	10,50	89	43
1,90	36	11	2,85	46	16	11,00	95	47
						12,00	102	51

Punta elicoidale taglio destro
Foret hélicoïdal coupe à droite
Spiralbohrer Rechtsschneidend
Twist drill right hand cutting

超硬ソリッドドリル
 右旋螺旋钻

MTB 35

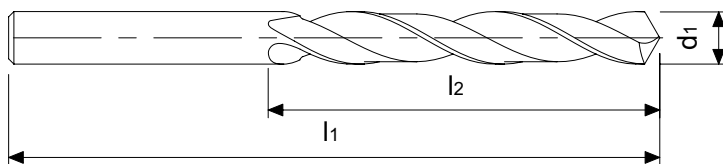

Campo d'impiego / Champ d'application / Einsatzbereich / Application field / 应用範圍 / 应用

HRC < 42	Inox Stainless	GG(G) / ghisa Ft / cast iron	Titanio Titan	ALU
----------	-------------------	---------------------------------	------------------	-----

d1 h6	l1	l2	d1 h6	l1	l2	d1 h6	l1	l2
0,30	28	4	1,70	40	16	3,20	50	20
0,35	30	5	1,75	40	16	3,30	50	20
0,40	30	5	1,80	40	16	3,40	50	20
0,45	30	5	1,85	40	16	3,50	50	20
0,50	30	5	1,90	40	16	3,60	50	20
0,55	30	5	1,95	40	16	3,70	50	20
0,60	30	5	2,00	40	16	3,80	50	20
0,65	30	6	2,05	40	18	3,90	50	20
0,70	30	6	2,10	40	18	4,00	50	20
0,75	30	8	2,15	40	18	4,10	50	25
0,80	30	8	2,20	40	18	4,20	50	25
0,85	30	9	2,25	40	18	4,30	50	25
0,90	30	9	2,30	40	18	4,40	50	25
0,95	30	10	2,35	40	18	4,50	50	25
1,00	30	10	2,40	40	18	4,60	50	25
1,05	30	10	2,45	40	18	4,70	50	25
1,10	30	10	2,50	40	18	4,80	50	25
1,15	30	12	2,55	45	18	4,90	50	25
1,20	30	12	2,60	45	18	5,00	50	25
1,25	30	12	2,65	45	18	5,10	50	25
1,30	30	12	2,70	45	18	5,20	50	25
1,35	30	12	2,75	45	18	5,30	50	25
1,40	30	12	2,80	45	18	5,40	50	25
1,45	30	12	2,85	45	18	5,50	50	25
1,50	30	12	2,90	45	18	5,60	50	25
1,55	40	16	2,95	45	18	5,70	50	25
1,60	40	16	3,00	45	18	5,80	50	25
1,65	40	16	3,10	50	20	5,90	50	25
			3,17	50	20	6,00	50	25

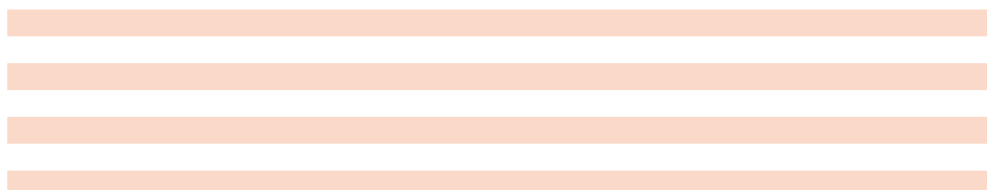

Punta elicoidale taglio sinistro
Foret hélicoïdal coupe à gauche
Spiralbohrer Linksschneidend
Twist drill left hand cutting

超硬ソリッドドリル、左刃
 左旋麻花钻

MTB 35/L

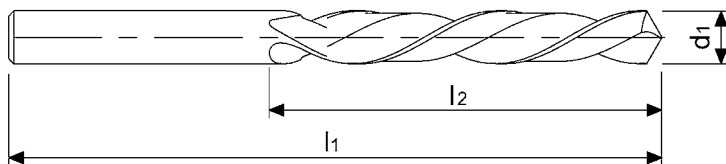
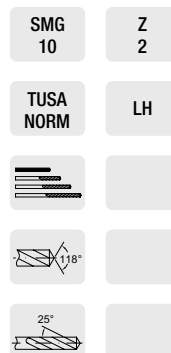

Campo d'impiego / Champ d'application / Einsatzbereich / Application field / 応用範囲 / 应用

HRC < 42	Inox Stainless	GG(G) / ghisa Ft / cast iron	Titanio Titan	ALU
--------------------	---------------------------	---	--------------------------	------------

d1 h6	l1	l2	d1 h6	l1	l2	d1 h6	l1	l2
0,50	30	5	1,85	40	16	3,30	50	20
0,55	30	5	1,90	40	16	3,40	50	20
0,60	30	5	1,95	40	16	3,50	50	20
0,65	30	6	2,00	40	16	3,60	50	20
0,70	30	6	2,05	40	18	3,70	50	20
0,75	30	8	2,10	40	18	3,80	50	20
0,80	30	8	2,15	40	18	3,90	50	20
0,85	30	9	2,20	40	18	4,00	50	20
0,90	30	9	2,25	40	18	4,10	50	25
0,95	30	10	2,30	40	18	4,20	50	25
1,00	30	10	2,35	40	18	4,30	50	25
1,05	30	10	2,40	40	18	4,40	50	25
1,10	30	10	2,45	40	18	4,50	50	25
1,15	30	12	2,50	40	18	4,60	50	25
1,20	30	12	2,55	45	18	4,70	50	25
1,25	30	12	2,60	45	18	4,80	50	25
1,30	30	12	2,65	45	18	4,90	50	25
1,35	30	12	2,70	45	18	5,00	50	25
1,40	30	12	2,75	45	18	5,10	50	25
1,45	30	12	2,80	45	18	5,20	50	25
1,50	30	12	2,85	45	18	5,30	50	25
1,55	40	16	2,90	45	18	5,40	50	25
1,60	40	16	2,95	45	18	5,50	50	25
1,65	40	16	3,00	45	18	5,60	50	25
1,70	40	16	3,10	50	20	5,70	50	25
1,75	40	16	3,17	50	20	5,80	50	25
1,80	40	16	3,20	50	20	5,90	50	25
						6,00	50	25

Punta da centro 120°

Foret à centrer 120°

NC Anbohrer 120°

Center drill 120°

センタードリル120°

中心钻 120°

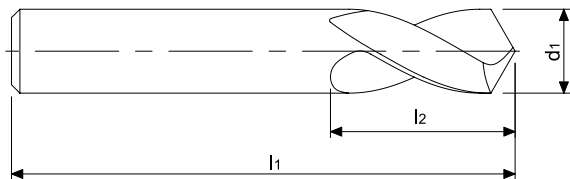

d1 h8 l1 l2

3,00	45	12
4,00	50	15
5,00	50	18
6,00	50	21
8,00	60	25
10,00	70	27
12,00	70	27
14,00	75	30
16,00	75	30

MTB 40

SMG
10

Z
2

TUSA
NORM

RH



Punta da centro 90°

Foret à centrer 90°

NC Anbohrer 90°

Center drill 90°

センタードリル90°

中心钻 90°

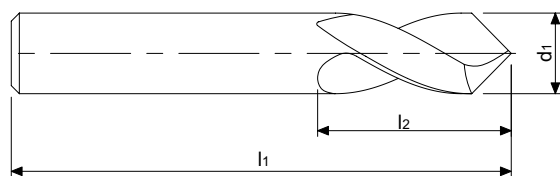

d1 h8 l1 l2

3,00	45	12
4,00	50	15
5,00	50	18
6,00	50	21
8,00	60	25
10,00	70	27
12,00	70	27
14,00	75	30
16,00	75	30

MTB 41

SMG
10

Z
2

TUSA
NORM

RH



TUSA[®]
Precision Tools SA



PUNTE SERIE LUNGHE
LONG SERIES DRILLS

MTB 45
MTB 50
MTB 60



SWISS MADE

Punta elicoidale taglio destro, serie medio-lunga
Foret hélicoïdal coupe à droite, série mi-longue
Spiralbohrer Rechtsschneidend, halb-lange Ausführung
Twist drill right hand cutting, half-long series
 超硬ソリッドドリル、セミロングシリーズ
 右旋螺旋钻，半长系列

MTB 45

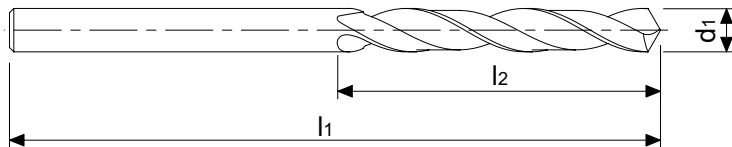

Campo d'impiego / Champ d'application / Einsatzbereich / Application field / 応用範囲 / 应用

HRC < 42	Inox Stainless	GG(G) / ghisa Ft / cast iron	Titanio Titan	ALU
----------	-------------------	---------------------------------	------------------	-----

d1	h6	l1	l2	d1	h6	l1	l2	d1	h6	l1	l2
0,30	40	8		3,20	71	32		6,10	102	50	*
0,40	40	8		3,30	73	35		6,20	102	50	*
0,50	40	8		3,40	73	35		6,30	102	50	*
0,60	40	8		3,50	73	35		6,40	105	50	*
0,70	50	15		3,60	76	37		6,50	105	50	
0,80	50	15		3,70	76	37		6,60	105	50	*
0,90	50	15		3,80	76	37		6,70	105	50	*
1,00	50	16		3,90	79	37		6,80	105	50	*
1,10	50	16		4,00	83	40		6,90	105	50	*
1,20	50	18		4,10	83	40		7,00	105	50	
1,30	50	18		4,20	83	40		7,10	108	52	*
1,40	50	18		4,30	83	40		7,20	108	52	*
1,50	50	24		4,40	86	42		7,30	108	52	*
1,60	55	24		4,50	86	42		7,40	111	52	*
1,70	55	24		4,60	86	42		7,50	111	52	
1,80	55	24		4,70	89	42		7,60	111	52	*
1,90	55	24		4,80	89	42		7,70	114	55	*
2,00	55	24		4,90	92	45		7,80	114	55	*
2,10	55	24		5,00	92	45		7,90	114	55	*
2,20	58	26		5,10	92	45		8,00	117	60	
2,30	58	26		5,20	95	45		8,50	121	60	*
2,40	61	26		5,30	95	45		9,00	124	65	*
2,50	61	26		5,40	95	45		9,50	127	65	*
2,60	64	28		5,50	95	45		10,00	130	70	*
2,70	64	28		5,60	98	45		10,50	137	70	*
2,80	67	30		5,70	98	45		11,00	140	70	*
2,90	71	30		5,80	98	45		11,50	143	70	*
3,00	71	30		5,90	98	45		12,00	149	70	*
3,10	71	32		6,00	102	50		12,50	149	70	*
								13,00	149	70	*

Disponibili su richiesta*
Min. 5 pz

Disponible sur demande*
Au moins 5 pièces

Available on request*
Minimum qty 5 pcs

Verfügbar auf Anfrage*
Mindestmenge 5 Stk

Punta elicoidale taglio destro, serie lunga
Foret hélicoidal coupe à droite, série longue
Spiralbohrer Rechtsschneidend, lange Ausführung
Twist drill right hand cutting, long series

MTB 50

超硬ソリッドドリル、ロングシリーズ
 右旋螺旋钻，长系列

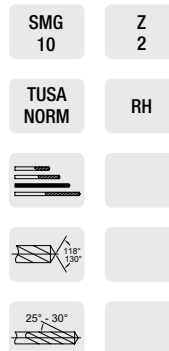
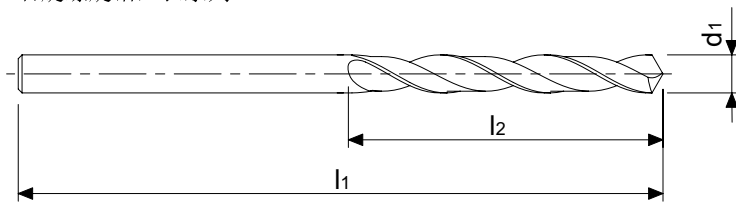

Campo d'impiego / Champ d'application / Einsatzbereich / Application field / 応用範囲 / 应用

HRC < 42	Inox Stainless	GG(G) / ghisa Ft / cast iron	Titanio Titan	ALU
--------------------	---------------------------	---	--------------------------	------------

d1 h6	l1	l2	d1 h6	l1	l2	d1 h6	l1	l2
1,00	75	25	3,10	100	50	5,30	150	75
1,10	75	25	3,20	100	50	5,40	150	75
1,20	75	25	3,30	100	50	5,50	150	75
1,30	75	25	3,40	100	50	5,60	150	75
1,40	75	30	3,50	100	50	5,70	150	75
1,50	75	30	3,60	100	50	5,80	150	75
1,60	75	30	3,70	100	50	5,90	150	75
1,70	75	30	3,80	100	50	6,00	150	75
1,80	75	30	3,90	100	50	6,50	150	75
1,90	75	30	4,00	100	50	7,00	150	75
2,00	75	30	4,10	100	50	7,50	150	75
2,10	75	30	4,20	100	50	8,00	150	75
2,20	75	30	4,30	100	50	8,50	150	75
2,30	75	30	4,40	100	50	9,00	150	75
2,40	100	35	4,50	100	50	9,50	150	75
2,50	100	35	4,60	100	50	10,00	150	75
2,60	100	35	4,70	100	50	10,50	200	90
2,70	100	35	4,80	100	50	11,00	200	90
2,80	100	35	4,90	100	50	11,50	200	90
2,90	100	35	5,00	150	75	12,00	200	90
3,00	100	50	5,10	150	75	12,50	200	90
			5,20	150	75	13,00	200	90

Punta elicoidale taglio destro, serie extra-lunga
Foret hélicoidal coupe à droite, série extra-longue
Spiralbohrer Rechtsschneidend, extra-lange Ausführung
Twist drill right hand cutting, extra-long series
 超硬ソリッドドリル、エキストラロングシリーズ
 右旋螺旋钻，特长系列

MTB 60

SMG 10	Z 2
TUSA NORM	RH

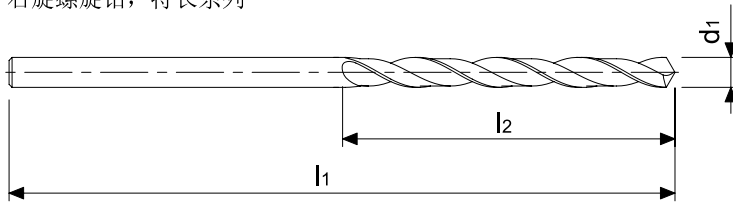

Campo d'impiego / Champ d'application / Einsatzbereich / Application field / 応用範囲 / 应用

HRC < 42	Inox Stainless	GG(G) / ghisa Ft / cast iron	Titanio Titan	ALU
----------	-------------------	---------------------------------	------------------	-----

d1	h6	l1	l2	d1	h6	l1	l2	d1	h6	l1	l2
1,00		100	50	2,90		150	75	4,90		150	75
1,10		100	50	3,00		150	75	5,00		200	100
1,20		100	50	3,10		150	75	5,10		200	100
1,30		100	50	3,20		150	75	5,20		200	100
1,40		100	50	3,30		150	75	5,30		200	100
1,50		100	50	3,40		150	75	5,40		200	100
1,60		100	50	3,50		150	75	5,50		200	100
1,70		100	50	3,60		150	75	5,60		200	100
1,80		100	50	3,70		150	75	5,70		200	100
1,90		100	50	3,80		150	75	5,80		200	100
2,00		100	50	3,90		150	75	5,90		200	100
2,10		100	50	4,00		150	75	6,00		200	100
2,20		100	50	4,10		150	75	6,50		200	105
2,30		100	50	4,20		150	75	7,00		200	105
2,40		150	75	4,30		150	75	7,50		200	105
2,50		150	75	4,40		150	75	8,00		200	105
2,60		150	75	4,50		150	75	8,50		250	130
2,70		150	75	4,60		150	75	9,00		250	130
2,80		150	75	4,70		150	75	9,50		250	145
				4,80		150	75	10,00		250	145

SERVIZIO DI RIAFFILATURA

Con il continuo aumento dei prezzi della materia prima, e i lunghi termini di approvvigionamento del materiale grezzo, un processo di rigenerazione degli utensili diventa sempre più interessante per i clienti.

L'incidenza del costo del materiale sul prezzo degli utensili è notevole e può arrivare in alcuni casi anche oltre il 60%.

Perché non approfittare di questa opportunità?

L'azienda Tusa Precision Tools, grazie alla sua decennale esperienza e alla professionalità del suo Team, è in grado di rigenerare nella massima qualità i propri utensili anche più volte, garantendo le prestazioni iniziali dei propri prodotti e abbattendo i costi di utilizzo.

Possiamo garantire dei servizi personalizzati e in caso di urgenze dei canali di servizio veloce, risparmiando tempo e danaro.

Contattate il nostro ufficio tecnico e discutete la migliore soluzione per la vostra azienda.

RE-SHARPENING SERVICE

Considering the fact that raw material price has surged consistently during last years and delivery time for raw material's supply is becoming longer and longer – it could be very interesting to take tools' re-sharpening process into consideration.

The incidence of raw material costs is really remarkable and can reach, to some extent, also 60%.

Why not make the most of this opportunity?

Owing to its experience and professional approach, TUSA PRECISION TOOLS SA can regenerate every tool more times, granting the initial performance and decreasing usage costs. Customized, fast service, saving time and money is TUSA's aim,

Get in touch with our technical team and find the best solution for your company!

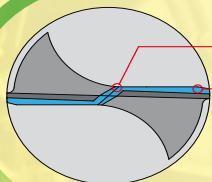

zona di usura
wear area

Utensile con taglienti rigenerati

Tool with regenerated cutting edges



Tool with worn cutting edges

Utensile con taglienti usurati

taglienti rigenerati
regenerated cutting edges

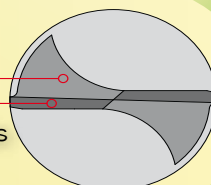

TUSA[®]

Precision Tools SA

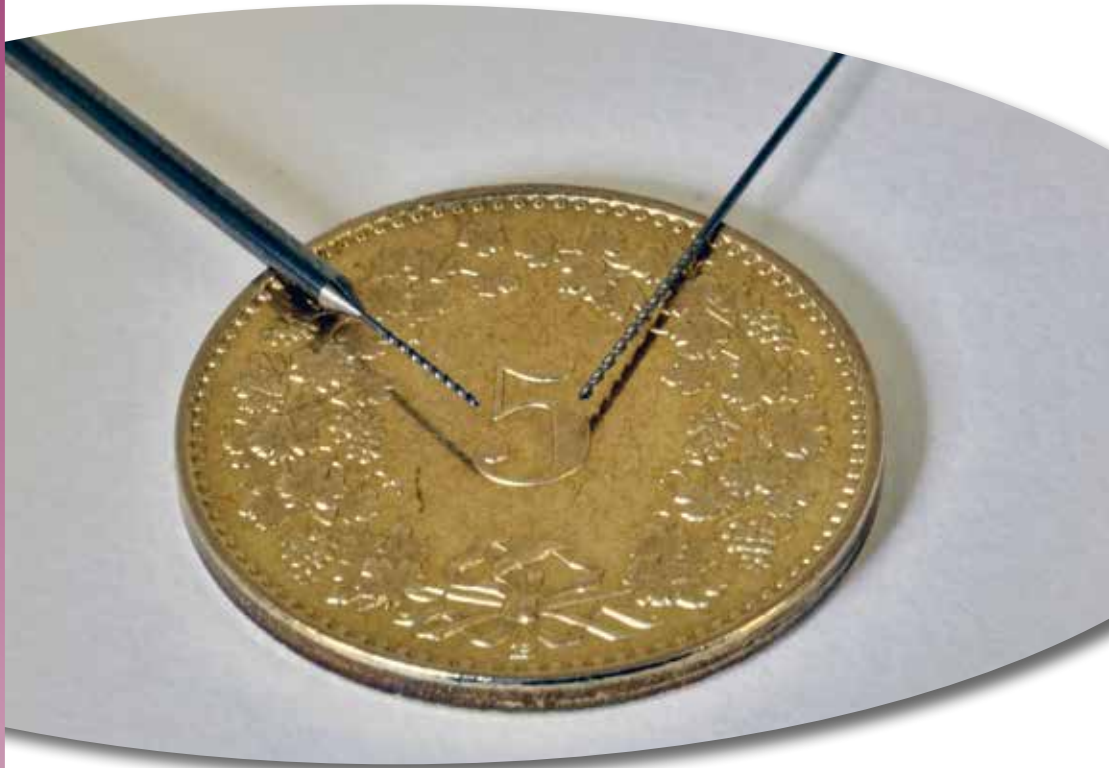

**MICROPUNTE
MICRO DRILLS**



**TC 35
TA 35**



SWISS MADE

Micropunta elicoidale taglio destro, gambo rinforzato
Micro-foret hélicoidal coupe à droite, queue renforcée
Microbohrer Rechtsschneidend, Verstärkter Schaft
Micro drill right hand cutting, reinforced shank
 マイクロソリッドドリル、ストロングシャンク
 右旋螺旋钻

TA 35

SMG 10	Z 2
TUSA NORM	RH
MICRO	
	
	

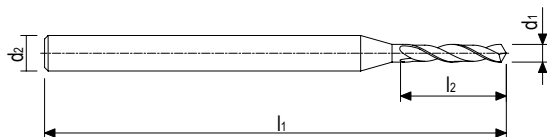

Campo d'impiego / Champ d'application / Einsatzbereich / Application field / 応用範囲 / 応用

HRC < 42	Inox Stainless	GG(G) / ghisa Ft / cast iron	Titanio Titan	ALU
----------	-------------------	---------------------------------	------------------	-----

d_1	h_6	d_2	h_6	l_1	l_2	d_1	h_6	d_2	h_6	l_1	l_2
0,20	1,00	30	3	1,10	1,50	30	10				
0,25	1,00	30	3	1,15	1,50	30	12				
0,30	1,00	30	3	1,20	1,50	30	12				
0,35	1,00	30	4	1,25	1,50	30	12				
0,40	1,00	30	4	1,30	1,50	30	12				
0,45	1,00	30	6	1,35	1,50	30	12				
0,50	1,00	30	6	1,40	1,50	30	12				
0,55	1,00	30	6	1,45	1,50	30	12				
0,60	1,00	30	6	1,50	2,00	30	12				
0,65	1,00	30	7	1,55	2,00	30	12				
0,70	1,00	30	7	1,60	2,00	30	12				
0,75	1,50	30	8	1,65	2,00	30	12				
0,80	1,50	30	8	1,70	2,00	30	12				
0,85	1,50	30	8	1,75	2,00	30	12				
0,90	1,50	30	8	1,80	2,00	30	12				
0,95	1,50	30	10	1,85	2,00	30	12				
1,00	1,50	30	10	1,90	2,00	30	12				
1,05	1,50	30	10	1,95	2,00	30	12				
				2,00	2,50	30	12				

TUSA[®]

Precision Tools SA

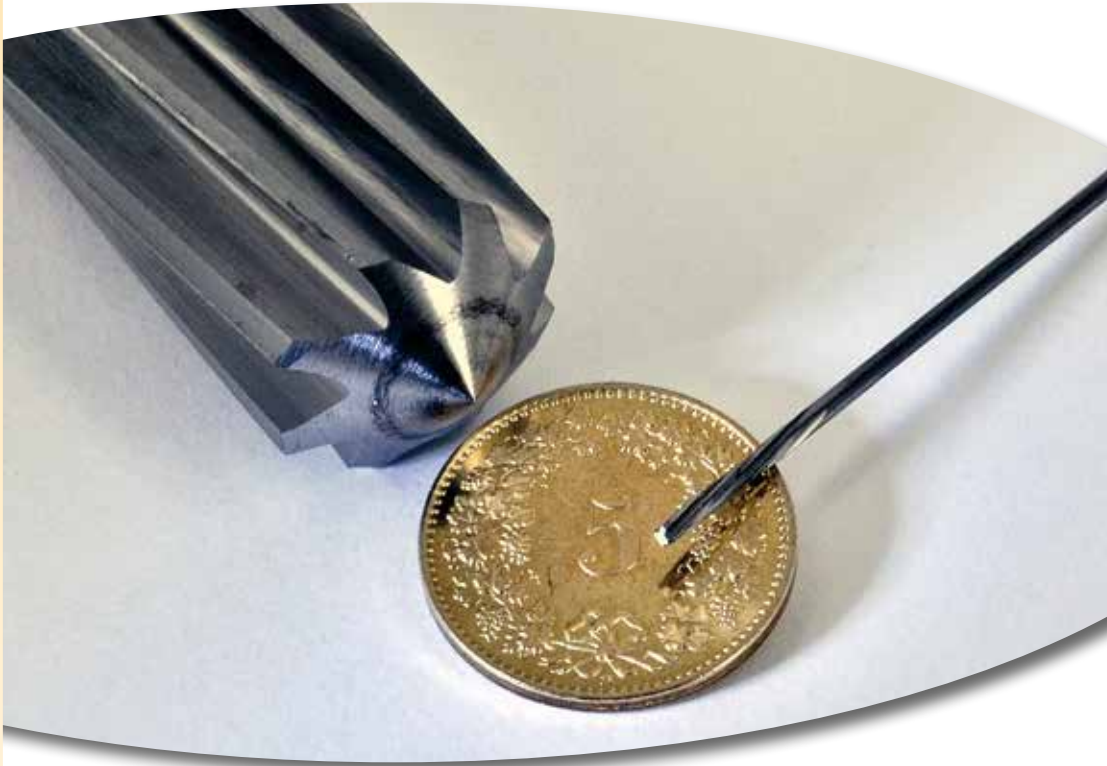

**ALESATORI
REAMERS**

 **SWISS MADE**

MS 402

Alesatore elicoidale a spirale sinistra, taglio destro, divisione irregolare
Alésoir avec hélice à gauche, coupe à droite, division irrégulière
Spiralgenutet Reibahle, links Drall, rechtsschneidend, ungleiche Teilung
Reamer with left-hand helix, right hand cut, irregular division

超硬ソリッドリーマ、右刃左ねじれ、不規則形状
 左旋铰刀，右旋切削 不规则分布

MS 402

SMG
10

Z
4 - 8

Similar
DIN 212

RH

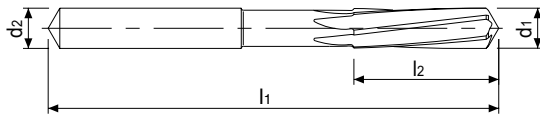

d_1	H7	l_1	l_2	z	d_1	H7	l_1	l_2	z	d_1	H7	l_1	l_2	z
1,00	40	5	4	4	2,30	53	12	4	4	3,70	70	18	4	4
1,05	40	5	4	4	2,35	53	12	4	4	3,75	70	18	4	4
1,10	40	7	4	4	2,40	57	14	4	4	3,80	75	19	4	4
1,15	40	7	4	4	2,45	57	14	4	4	3,85	75	19	4	4
1,20	40	7	4	4	2,50	57	14	4	4	3,90	75	19	4	4
1,25	40	7	4	4	2,55	57	14	4	4	3,97	75	19	4	4
1,30	40	7	4	4	2,60	61	14	4	4	3,98	75	19	4	4
1,35	40	7	4	4	2,65	61	14	4	4	3,99	75	19	4	4
1,40	40	8	4	4	2,70	61	15	4	4	4,00	75	19	4	4
1,45	40	8	4	4	2,75	61	15	4	4	4,50	80	21	4	4
1,50	40	8	4	4	2,80	61	15	4	4	5,00	86	23	6	6
1,55	43	8	4	4	2,85	61	15	4	4	5,50	93	26	6	6
1,60	43	9	4	4	2,90	61	15	4	4	6,00	93	26	6	6
1,65	43	9	4	4	2,97	61	15	4	4	6,50	101	28	6	6
1,70	46	10	4	4	2,98	61	15	4	4	7,00	109	31	6	6
1,75	46	10	4	4	2,99	61	15	4	4	7,50	109	31	6	6
1,80	46	10	4	4	3,00	61	15	4	4	8,00	117	33	6	6
1,85	46	10	4	4	3,01	65	16	4	4	8,50	117	33	6	6
1,90	46	11	4	4	3,02	65	16	4	4	9,00	125	36	6	6
1,95	46	11	4	4	3,03	65	16	4	4	9,50	125	36	6	6
1,97	49	11	4	4	3,06	65	16	4	4	10,00	133	38	6	6
1,98	49	11	4	4	3,10	65	16	4	4	10,50	133	38	6	*
1,99	49	11	4	4	3,15	65	16	4	4	11,00	142	41	6	*
2,00	49	11	4	4	3,20	65	16	4	4	11,50	142	41	6	*
2,01	49	11	4	4	3,25	65	16	4	4	12,00	151	44	6	*
2,02	49	11	4	4	3,30	65	16	4	4	12,50	151	44	6	*
2,03	49	11	4	4	3,35	70	18	4	4	13,00	151	44	6	*
2,06	49	11	4	4	3,40	70	18	4	4	13,50	160	47	8	*
2,10	49	11	4	4	3,45	70	18	4	4	14,00	160	47	8	*
2,15	49	11	4	4	3,50	70	18	4	4	14,50	162	50	8	*
2,20	53	12	4	4	3,55	70	18	4	4	15,00	162	50	8	*
2,25	53	12	4	4	3,60	70	18	4	4	15,50	170	52	8	*
					3,65	70	18	4	4	16,00	170	52	8	*

Disponibili su richiesta*
Min. 5 pz

Disponible sur demande*
Au moins 5 pièces

Available on request*
Minimum qty 5 pcs

Verfügbar auf Anfrage*
Mindestmenge 5 Stk



Alesatori Speciali

Una grande peculiarità della nostra azienda sono gli alesatori con diametri nominali speciali in metallo duro integrale.

Possiamo infatti fornire alesatori per ogni tipologia di utilizzo, anche rivestiti, con tolleranze certificate di 0.003 mm.

Da 4 a 8 denti irregolari, elica destra e taglio destro, elica sinistra e taglio destro oppure elica diritta e taglio destro.

Non esitate a contattare il nostro ufficio tecnico che potrà aiutarvi a trovare la soluzione ideale alla vostra tipologia di applicazione e a ottenere risultati di altissima qualità.



Special Reamers

A big peculiarity of our company is represented by tungsten carbide reamers with special nominal diameters.

We can supply you reamers suitable for any kind of applications, also coated ones, with certified tolerances of 0.003 mm.

Furthermore we can produce reamers with irregular teeth Z=4-8, with right helix and right cutting, left helix and right cutting or with straight helix and right cutting.

Therefore please do not hesitate to contact our technical office where you can find the ideal solution for your application and at the same time you can get high quality and favourable results.



TUSA[®]

Precision Tools SA



FRESE ELICOIDALI 3-4 DENTI
TWIST END MILLS 3-4 FLUTES

MS 131 XL/XLS
MS 141 XL/XLS

 **SWISS MADE**

Fresa elicoidale, 3 taglienti, taglio al centro
Fraise hélicoïdale, 3 dents, coupe au centre
3 Schneiden-Fräser, spiralgenutet, mit Zentrumschnitt
Twist end mill, 3 flutes, center cutting

精密超硬エンドミル、3枚刃
 螺旋立铣刀，3刃，中心切割

MS 131
XL/XLS

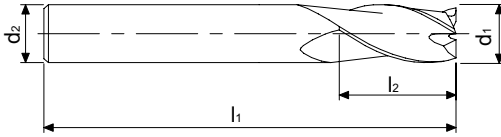

Campo d'impiego / Champ d'application / Einsatzbereich / Application field / 应用範圍 / 应用

HRC < 48	Inox Stainless	GG(G) / ghisa Ft / cast iron	Titanio Titan	ALU
----------	-------------------	---------------------------------	------------------	-----

MS 131				MS 131 XL				MS 131 XLS									
d ₁	h ₁₁	d ₂	h ₆	l ₁	l ₂	d ₁	h ₁₁	d ₂	h ₆	l ₁	l ₂	d ₁	h ₁₁	d ₂	h ₆	l ₁	l ₂
2,00	2,00	42	6	3,00	3,00	55	20	3,00	3,00	70	30	3,00	3,00	4,00	4,00	75	40
2,50	2,50	42	7	4,00	4,00	60	20	4,00	4,00	80	40	4,00	4,00	5,00	5,00	80	40
3,00	3,00	45	7	5,00	5,00	60	20	5,00	5,00	80	40	5,00	5,00	6,00	6,00	80	45
3,50	3,50	50	7	6,00	6,00	65	24	6,00	6,00	100	50	6,00	6,00	8,00	8,00	100	50
4,00	4,00	50	8	8,00	8,00	80	32	8,00	8,00	100	50	8,00	8,00	10,00	10,00	100	50
4,50	4,50	50	8	10,00	10,00	80	32	10,00	10,00	150	70	10,00	10,00	12,00	12,00	150	70
5,00	5,00	50	10	12,00	12,00	100	50	12,00	12,00	150	70	12,00	12,00	14,00	14,00	150	75
5,50	5,50	57	10	14,00	14,00	100	50	14,00	14,00	150	75	14,00	14,00	16,00	16,00	150	75
6,00	6,00	57	10	16,00	16,00	100	50	16,00	16,00	150	75	16,00	16,00	18,00	18,00	150	75
7,00	7,00	60	13	18,00	18,00	100	50	18,00	18,00	150	75	18,00	18,00	20,00	20,00	150	75
8,00	8,00	63	16	20,00	20,00	100	50	20,00	20,00	150	75	20,00	20,00				
9,00	9,00	67	16														
10,00	10,00	72	19														
11,00	11,00	83	22	*													
12,00	12,00	83	22	*													
13,00	13,00	83	22	*													
14,00	14,00	83	22	*													
15,00	15,00	92	26	*													
16,00	16,00	92	26	*													
18,00	18,00	92	26	*													
20,00	20,00	101	32	*													

Disponibili su richiesta*
 Min. 5 pz
 DIN 1835B su richiesta

Disponible sur demande*
 Au moins 5 pièces
 DIN 1835B sur demande

Available on request*
 Minimum qty 5 pcs
 DIN 1835B on request

Verfügbar auf Anfrage*
 Mindestmenge 5 Stk
 DIN 1835B auf Anfrage

Fresa elicoidale, 4 taglienti, taglio al centro
Fraise hélicoidale, 4 dents, coupe au centre
4 Schneiden-Fräser, spiralgenutet, mit Zentrumschnitt
Twist end mill, 4 flutes, center cutting

精密超硬エンドミル、4枚刃
 螺旋立铣刀，4刃，中心切割

MS 141
XL/XLS

SMG
10

Z
4

DIN
6528

XL-XLS=
TUSA NORM

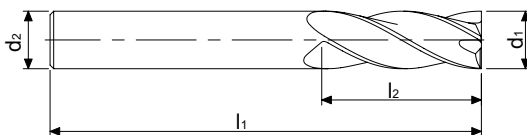
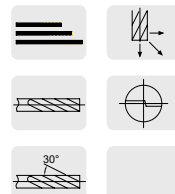

Campo d'impiego / Champ d'application / Einsatzbereich / Application field / 応用範囲 / 应用

HRC < 48

Inox
Stainless

GG(G) / ghisa
Ft / cast iron

Titanio
Titan

ALU

MS 141

MS 141 XL

MS 141 XLS

d1	h11	d2	h6	l1	l2	d1	h11	d2	h6	l1	l2	d1	h11	d2	h6	l1	l2
2,00	2,00	42	7	3,00	3,00	55	20	3,00	3,00	70	30	3,00	3,00	75	40		
2,50	2,50	42	8	4,00	4,00	60	20	4,00	4,00	80	40	4,00	4,00	80	40		
3,00	3,00	45	8	5,00	5,00	60	20	5,00	5,00	80	40	5,00	5,00	80	40		
3,50	3,50	50	10	6,00	6,00	65	24	6,00	6,00	80	45	6,00	6,00	80	45		
4,00	4,00	50	11	8,00	8,00	80	32	8,00	8,00	100	50	8,00	8,00	100	50		
4,50	4,50	50	11	10,00	10,00	80	32	10,00	10,00	100	50	10,00	10,00	100	50		
5,00	5,00	50	13	12,00	12,00	100	50	12,00	12,00	150	70	12,00	12,00	150	70	*	*
5,50	5,50	57	13	14,00	14,00	100	50	14,00	14,00	150	75	14,00	14,00	150	75	*	*
6,00	6,00	57	13	16,00	16,00	100	50	16,00	16,00	150	75	16,00	16,00	150	75	*	*
6,50	6,50	60	16	18,00	18,00	100	50	18,00	18,00	150	75	18,00	18,00	150	75	*	*
7,00	7,00	60	16	20,00	20,00	100	50	20,00	20,00	150	75	20,00	20,00	150	75	*	*
7,50	7,50	63	19														
8,00	8,00	63	19														
8,50	8,50	67	19														
9,00	9,00	67	19														
9,50	9,50	72	22														
10,00	10,00	72	22														
11,00	11,00	83	26	*													
12,00	12,00	83	26	*													
13,00	13,00	83	26	*													
14,00	14,00	83	26	*													
15,00	15,00	92	32	*													
16,00	16,00	92	32	*													
18,00	18,00	92	32	*													
20,00	20,00	101	38	*													

Disponibili su richiesta*
Min. 5 pz

DIN 1835B su richiesta

Disponible sur demande*
Au moins 5 pièces

DIN 1835B sur demande

Available on request*
Minimum qty 5 pcs

DIN 1835B on request

Verfügbar auf Anfrage*
Mindestmenge 5 Stk

DIN 1835B auf Anfrage



FRESE ELICOIDALI 2 DENTI
TWIST END MILLS 2 FLUTES

MS 122 XL/XLS

MS 123 XL/XLS

MS 124 per alluminio
for aluminium



SWISS MADE

Fresa elicoidale, 2 taglienti, taglio al centro
Fraise hélicoïdale, 2 dents, coupe au centre
2 Schneiden-Fräser, spiralgenutet, mit Zentrumschnitt
Twist end mill, 2 flutes, center cutting

精密超硬エンドミル、2枚刃、センターカット
 螺旋立铣刀，2刃，中心切割

MS 122
XL/XLS

SMG
10

Z
2

DIN
6528

XL-XLS=
TUSA NORM

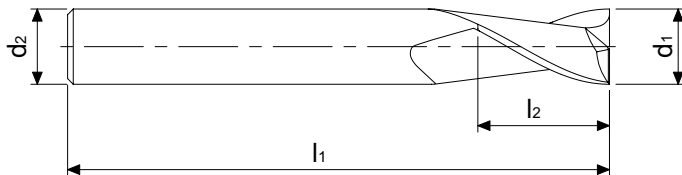
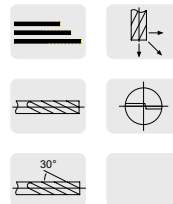

Campo d'impiego / Champ d'application / Einsatzbereich / Application field / 応用範囲 / 应用

HRC < 48

Inox
Stainless

GG(G) / ghisa
Ft / cast iron

Titanio
Titan

ALU

MS 122

MS 122 XL

MS 122 XLS

d1	h11	d2	h6	l1	l2	d1	h11	d2	h6	l1	l2	d1	h11	d2	h6	l1	l2
2,00	2,00	42	6	3,00	3,00	55	20	3,00	3,00	70	30	3,00	3,00	70	30		
2,50	2,50	42	7	4,00	4,00	60	20	4,00	4,00	75	40	4,00	4,00	75	40		
3,00	3,00	45	7	5,00	5,00	60	20	5,00	5,00	80	40	5,00	5,00	80	40		
3,50	3,50	50	7	6,00	6,00	65	24	6,00	6,00	80	45	6,00	6,00	80	45		
4,00	4,00	50	8	8,00	8,00	80	32	8,00	8,00	100	50	8,00	8,00	100	50		
4,50	4,50	50	8	10,00	10,00	80	32	10,00	10,00	100	50	10,00	10,00	100	50		
5,00	5,00	50	10	12,00	12,00	100	50	12,00	12,00	150	70	12,00	12,00	150	70	*	*
5,50	5,50	57	10	14,00	14,00	100	50	14,00	14,00	150	75	14,00	14,00	150	75	*	*
6,00	6,00	57	10	16,00	16,00	100	50	16,00	16,00	150	75	16,00	16,00	150	75	*	*
7,00	7,00	60	13	18,00	18,00	100	50	18,00	18,00	150	75	18,00	18,00	150	75	*	*
8,00	8,00	63	16	20,00	20,00	100	50	20,00	20,00	150	75	20,00	20,00	150	75	*	*
9,00	9,00	67	16														
10,00	10,00	72	19														
11,00	11,00	83	22	*													
12,00	12,00	83	22	*													
14,00	14,00	83	22	*													
16,00	16,00	92	26	*													
18,00	18,00	92	26	*													
20,00	20,00	101	32	*													

Disponibili su richiesta*
Min. 5 pz

Disponible sur demande*
Au moins 5 pièces

Available on request*
Minimum qty 5 pcs

Verfügbar auf Anfrage*
Mindestmenge 5 Stk

DIN 1835B su richiesta

DIN 1835B sur demande

DIN 1835B on request

DIN 1835B auf Anfrage

Fresa elicoidale a testa raggiata, 2 taglienti
Fraise hélicoïdale hémisphérique, 2 dents
Radiusfräser, 2-Schneiden, spiralgenutet
Radius twist end mill, 2 flutes

超硬精密ボールエンドミル、2枚刃
 球头螺旋立铣刀，2刃

MS 123
XL/XLS

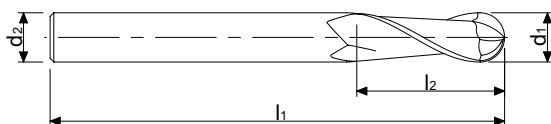
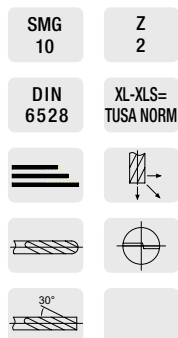

Campo d'impiego / Champ d'application / Einsatzbereich / Application field / 应用範圍 / 应用

HRC < 48	Inox Stainless	GG(G) / ghisa Ft / cast iron	Titanio Titan	ALU
----------	-------------------	---------------------------------	------------------	-----

MS 123					MS 123 XL					MS 123 XLS							
d ₁	h ₁₁	d ₂	h ₆	l ₁	l ₂	d ₁	h ₁₁	d ₂	h ₆	l ₁	l ₂	d ₁	h ₁₁	d ₂	h ₆	l ₁	l ₂
2,00	2,00	42	6	3,00	3,00	55	20	3,00	3,00	70	30						
2,50	2,50	42	7	4,00	4,00	60	20	4,00	4,00	75	40						
3,00	3,00	45	7	5,00	5,00	60	20	5,00	5,00	80	40						
3,50	3,50	50	7	6,00	6,00	65	24	6,00	6,00	80	45						
4,00	4,00	50	8	8,00	8,00	80	32	8,00	8,00	100	50						
4,50	4,50	50	8	10,00	10,00	80	32	10,00	10,00	100	50						
5,00	5,00	50	10	12,00	12,00	100	50	*	12,00	12,00	150	70	*				
5,50	5,50	57	10	14,00	14,00	100	50	*	14,00	14,00	150	75	*				
6,00	6,00	57	10	16,00	16,00	100	50	*	16,00	16,00	150	75	*				
7,00	7,00	60	13	20,00	20,00	100	50	*	20,00	20,00	150	75	*				
8,00	8,00	63	16														
9,00	9,00	67	16														
10,00	10,00	72	19														
11,00	11,00	83	22	*													
12,00	12,00	83	22	*													
14,00	14,00	83	22	*													
16,00	16,00	92	26	*													
18,00	18,00	92	26	*													
20,00	20,00	101	32	*													

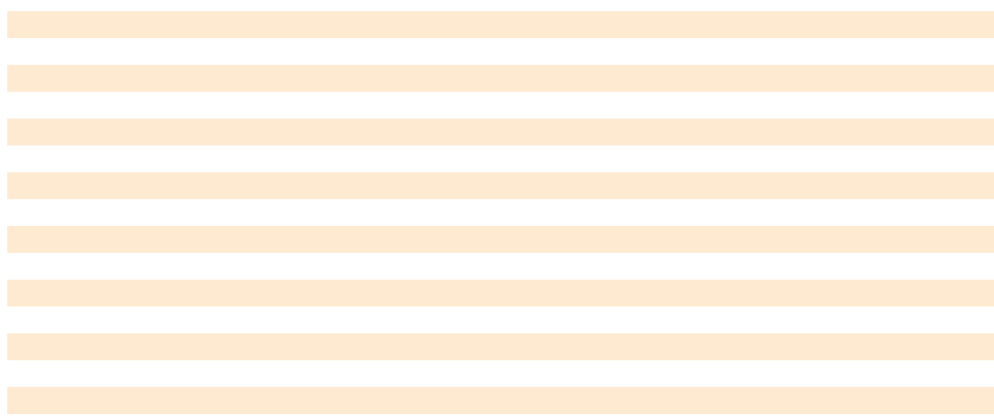

Disponibili su richiesta* Min. 5 pz	Disponible sur demande* Au moins 5 pièces	Available on request* Minimum qty 5 pcs	Verfügbar auf Anfrage* Mindestmenge 5 Stk
DIN 1835B su richiesta	DIN 1835B sur demande	DIN 1835B on request	DIN 1835B auf Anfrage

Fresa elicoidale per alte prestazioni, 2 taglienti, taglio al centro
Fraise hélicoidale pour hautes performances, 2 dents, coupe au centre
Hochleistungsfräser, 2 Schneiden, mit Zentrumschnitt
High-performance twist end mill, 2 flutes, center cutting
 高性能精密超硬エンドミル、2枚刃、センターカット
 高性能螺旋立铣刀，2刃，中心切割

MS 124

SMG
10

Z
2

TUSA
NORM



HSC

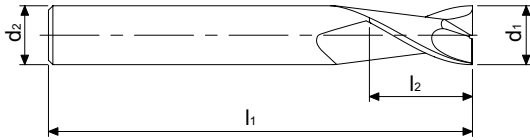

Campo d'impiego / Champ d'application / Einsatzbereich / Application field / 応用範囲 / 应用

ALU

PLASTIC

CU
Rame/Copper

d1	h11	d2	h6	l1	l2
2,00	2,00	40	10		
3,00	3,00	40	12		
4,00	4,00	40	12		
5,00	5,00	50	12		
6,00	6,00	60	18		
7,00	7,00	60	18		
8,00	8,00	60	18		
9,00	9,00	70	22		
10,00	10,00	70	22		
12,00	12,00	70	22	*	
14,00	14,00	80	25	*	
16,00	16,00	80	25	*	
18,00	18,00	100	30	*	
20,00	20,00	100	35	*	

Disponibili su richiesta*
Min. 5 pz

Disponible sur demande*
Au moins 5 pièces

Available on request*
Minimum qty 5 pcs

Verfügbar auf Anfrage*
Mindestmenge 5 Stk

Frese speciali

L'azienda TUSA PRECISION TOOLS propone e realizza un'ampia gamma di frese con caratteristiche specifiche per ogni esigenza produttiva, frutto di una vasta esperienza maturata negli anni e del continuo contatto con la clientela. Vi offriamo utensili performanti a prezzi competitivi, costruiti con metallo duro di prima scelta, ad elica destra, sinistra oppure dritta con profili più o meno complessi e dove necessario anche la possibilità di rivestire gli utensili. Il nostro ufficio tecnico sarà sicuramente in grado di trovare la soluzione ideale alla vostra tipologia di lavorazione, non esitate a contattarci.

Special end mills

The company TUSA PRECISION TOOLS produces a wide range of endmills which have specific features suitable for every kind of productive needs – our endmills are the result of a deep experience reached thanks to the continuous mutual exchange with our customers. We produce high-performing tools at competitive prices, using carbide material of high-quality – the endmills can have right, left or straight helix – more or less complex profile and eventual coating. Don't hesitate to contact us ! Our technical department will surely be able to find the ideal solution for your applications.



TUSA[®]

Precision Tools SA

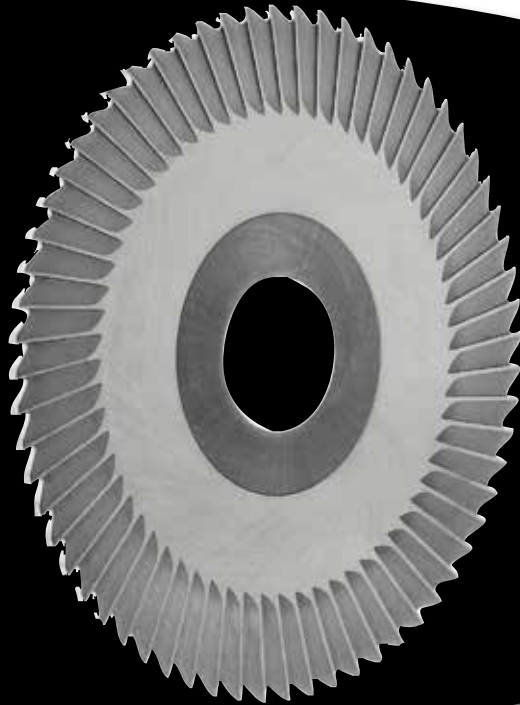

Frese e seghe circolari in metallo duro
Carbide circular cutters and saws



SWISS MADE

Frese circolari a dentatura fine - forma A
Fraises circulaires à denture fine - forme A
Kreissägeblättern Feine Verzahnung - Form A
Solid carbide slitting saws with fine teeth - form A
 超硬スリットタイプ、細刃-フォームA
 整体硬质合金精齿切割刀-A型

Frese circolari a dentatura grossa - forma A
Fraises circulaires à denture grossière - forme A
Kreissägeblättern Grosse Verzahnung - Form A
Solid carbide slitting saws with large teeth - form A
 超硬スリットタイプ、大型刃-フォームA
 整体硬质合金大齿切割刀-A型

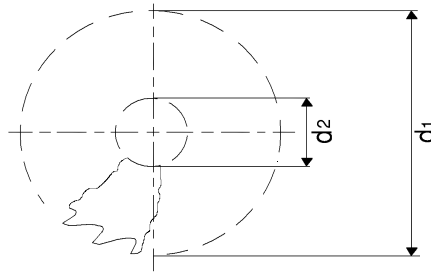
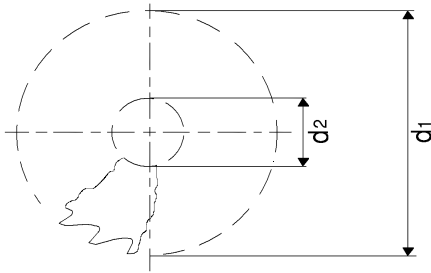

DIN 1837 A

spessore / thickness / breite / épaisseur / espesor

Ø	Ø	0,10	0,15	0,20	0,25	0,30	0,35	0,40	0,50	0,60	0,70	0,80	0,90	1,00	1,10	1,20	1,30	1,40	1,50	1,60	1,70	1,80	1,90	2,00	2,50	3,00	3,50	4,00	4,50	5,00	5,50	6,00			
15	5	64	64	64	64	64	64	64	48	48	48	40	40	40	40	40	40	40	40	40	40	40	40	40	40	40	40	40	40	40	40	40	40	40	
20	5	80	80	80	64	64	64	64	48	48	48	48	40	40	40	40	40	40	40	40	40	40	40	40	32	32	32	32	24	24	24	24	24	24	
25	8	80	80	80	80	80	64	64	64	64	48	48	48	48	48	48	48	48	48	48	48	48	48	48	48	48	48	48	48	48	48	48	48	48	
30	8	100	100	100	100	80	80	80	80	80	64	64	64	64	64	64	64	64	64	64	64	64	64	64	64	64	64	64	64	64	64	64	64	64	
40	10	128	128	128	100	100	100	100	100	80	80	80	80	80	80	80	80	80	80	80	80	80	80	80	80	80	80	80	80	80	80	80	80	80	
50	13	128	128	128	128	100	100	100	100	100	80	80	80	80	80	80	80	80	80	80	80	80	80	80	80	80	80	80	80	80	80	80	80	80	
63	16			160	160	128	128	128	128	100	100	100	100	100	100	100	100	100	100	100	100	100	100	100	100	100	100	100	100	100	100	100	100	100	
80	22					160	160	160	160	128	128	128	128	128	128	128	128	128	128	128	128	128	128	128	128	128	128	128	128	128	128	128	128	128	
100	22							160	160	128	128	128	128	128	128	128	128	128	128	128	128	128	128	128	128	128	128	128	128	128	128	128	128	128	
125	22									160	160	160	160	160	128	128	128	128	128	128	128	128	128	128	128	128	128	128	128	128	128	128	128	128	
150	32													150	150																				
160	32													160	160																				
200	32																																		

dimensioni in mm / dimensions in mm / abmessungen in mm / dimensions en mm / dimensiones en mm

DIN 1838 B

spessore / thickness / breite / épaisseur / espesor

Ø	Ø	0,10	0,15	0,20	0,25	0,30	0,35	0,40	0,50	0,60	0,70	0,80	0,90	1,00	1,10	1,20	1,30	1,40	1,50	1,60	1,70	1,80	1,90	2,00	2,50	3,00	3,50	4,00	4,50	5,00	5,50	6,00			
15	5			20	20	20	20	20	20	20	20	20	20	20	20	20	20	20	20	20	20	20	20	20	20	20	20	20	20	20	20	20	20		
20	5			20	20	20	20	20	20	20	20	20	20	20	20	20	20	20	20	20	20	20	20	20	20	20	20	20	20	20	20	20	20	20	
25	8			20	20	20	20	20	20	20	20	20	20	20	20	20	20	20	20	20	20	20	20	20	20	20	20	20	20	20	20	20	20	20	
30	8			30	30	30	30	30	30	30	24	24	24	24	24	24	24	24	24	24	24	24	24	24	24	24	24	24	24	24	24	24	24	24	
40	10			40	40	40	40	40	40	40	40	40	32	32	32	32	32	32	32	32	32	32	32	32	32	32	32	32	32	32	32	32	32	32	
50	13			48	48	48	48	48	48	48	48	40	40	40	40	40	40	40	40	40	40	40	40	40	40	40	40	40	40	40	40	40	40	40	
63	16					64	64	64	64	64	48	48	48	48	48	48	48	48	48	48	48	48	48	48	48	48	48	48	48	48	48	48	48	48	
80	22					64	64	64	64	64	64	64	64	64	64	64	64	64	64	64	64	64	64	64	64	64	64	64	64	64	64	64	64	64	
100	22							80	80	80	80	80	80	80	80	80	80	80	80	80	80	80	80	80	80	80	80	80	80	80	80	80	80	80	
125	22								80	80	80	80	80	80	80	80	80	80	80	80	80	80	80	80	80	80	80	80	80	80	80	80	80	80	
150	32													80	80																				
160	32													80	80																				
200	32																																		

dimensioni in mm / dimensions in mm / abmessungen in mm / dimensions en mm / dimensiones en mm

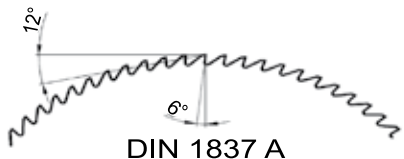

DIN 1837 A

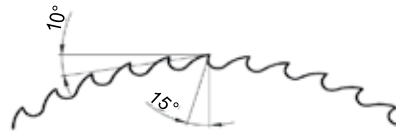

DIN 1838 B

Dentatura Fine/Fine Tothing/Fein Verzahnung/Denture Fine/Dentado Fino

Dentatura Grossa/Large Tothing/Gross Verzahnung/Denture Grosse/Dentado Grueso



Frese circolari a profilo in metallo duro

Carbide form circular cutters

Le frese circolari profilate sono prodotte dal diametro 5 mm al diametro 160 mm. Siamo in grado di realizzare frese a profilo costante con spoglia logaritmica - indifferentemente con denti dritti e con denti elicoidali. La spoglia logaritmica garantisce fedeltà al profilo e all'angolo di taglio anche dopo diverse riaffilature, riducendo i costi di utilizzo.

In base al materiale da lavorare e alle condizioni di utilizzo realizziamo specifiche costruzioni con vari tipi di dentatura (fine, grossa, extrafine, elicoidale ed alternata). Inoltre per particolari impieghi le frese possono essere fornite con sede linguetta o fori di trascinamento. Per tutte le frese, se l'impiego lo necessita, è possibile applicare il rivestimento più adatto.



Form circular cutters are produced from dia. 5.00 mm to dia. 160.00 mm.

Our production dept. can produce constant profile cutters with logarithmic relief grinding, with straight as well as with spiral toothing.

Logarithmic relief grinding guarantees faithfulness to profile and cutting angle, even after several re-sharpening operations. In this way labour costs are reduced.

Depending on working material and conditions of use, we can also produce specific tools with many different toothing types (fine, large, extrafine, spiral and alternate).

Furthermore, in case of particular applications, cutters can be provided with keyway or dragging holes.

For all cutters, it is possible to choose among a wide variety of coating types, according to the kind of application desired.



TUSA[®]

Precision Tools SA



TUSA TOP DRILL



TTD 203
TTD 207
MTB 27



SWISS MADE

Punta elicoidale ad alte prestazioni, taglio destro, gambo rinforzato
Foret hélicoidal à hautes performances, coupe à droite, queue renforcée
Hochleistungs-Spiralbohrer, Rechtsschneidend, Verstärkter Schaft
High-performance twist drill, right hand cutting, reinforced shank
 高性能ドリル3× D、ストロングシャンク
 高性能右旋螺旋钻，有加强柄

TTD 203

SMG SP	Z 2
TUSA NORM	RH
3×D	TiALN
	
	

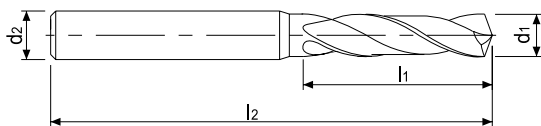

Campo d'impiego / Champ d'application / Einsatzbereich / Application field / 応用範囲 / 應用

HRC < 60	Inox Stainless	GG(G)/ghisa Ft/cast iron	Titanio Titan	ALU
----------	-------------------	-----------------------------	------------------	-----

d_1	h_5	d_2	h_6	l_1	l_2	d_1	h_5	d_2	h_6	l_1	l_2
0,80	3,0	3,4	38			1,90	3,0	8,1	45		
0,85	3,0	3,6	38	*		1,95	3,0	8,3	45	*	
0,90	3,0	3,8	38			2,00	3,0	8,5	45		
0,95	3,0	4,0	38	*		2,05	3,0	8,7	45	*	
1,00	3,0	4,3	38			2,10	3,0	8,9	45		
1,05	3,0	4,5	38	*		2,15	3,0	9,1	45	*	
1,10	3,0	4,7	38			2,20	3,0	9,4	45		
1,15	3,0	4,9	38	*		2,25	3,0	9,6	45	*	
1,20	3,0	5,1	38			2,30	3,0	9,8	45		
1,25	3,0	5,3	38	*		2,35	3,0	10,0	45	*	
1,30	3,0	5,5	38			2,40	3,0	10,2	45		
1,35	3,0	5,7	38	*		2,45	3,0	10,4	45	*	
1,40	3,0	6,0	38			2,50	3,0	10,6	45		
1,45	3,0	6,2	45	*		2,55	3,0	10,8	45	*	
1,50	3,0	6,4	45			2,60	3,0	11,1	45		
1,55	3,0	6,6	45	*		2,65	3,0	11,3	45	*	
1,60	3,0	6,8	45			2,70	3,0	11,5	45		
1,65	3,0	7,0	45	*		2,75	3,0	11,7	45	*	
1,70	3,0	7,2	45			2,80	3,0	11,9	45		
1,75	3,0	7,4	45	*		2,85	3,0	12,1	45	*	
1,80	3,0	7,7	45			2,90	3,0	12,3	45		
1,85	3,0	7,9	45	*		2,95	3,0	12,5	45	*	
						3,00	3,0	12,8	45		

Disponibili su richiesta*
Min. 5 pz

Disponible sur demande*
Au moins 5 pièces

Available on request*
Minimum qty 5 pcs

Verfügbar auf Anfrage*
Mindestmenge 5 Stk

Punta elicoidale ad alte prestazioni, taglio destro, gambo rinforzato
Foret hélicoïdal à hautes performances, coupe à droite, queue renforcée
Hochleistungs-Spiralbohrer, Rechtsschneidend, Verstärkter Schaft
High-performance twist drill, right hand cutting, reinforced shank
 高性能ドリル7× D、ストロングシャンク
 高性能右旋螺旋钻，有加强柄

TTD 207

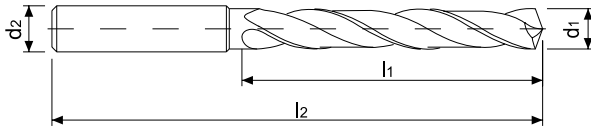

Campo d'impiego / Champ d'application / Einsatzbereich / Application field / 应用范围 / 应用

HRC < 60	Inox Stainless	GG(G)/ghisa Ft/cast iron	Titanio Titan	ALU
----------	-------------------	-----------------------------	------------------	-----

d1	h5	d2	h6	l1	l2	d1	h5	d2	h6	l1	l2
0,80	3,0	5,8		53		1,90	3,0	13,8		53	
0,85	3,0	6,2		53	*	1,95	3,0	14,1		53	*
0,90	3,0	6,5		53		2,00	3,0	14,5		53	
0,95	3,0	6,9		53	*	2,05	3,0	14,9		53	*
1,00	3,0	7,3		53		2,10	3,0	15,2		53	
1,05	3,0	7,6		53	*	2,15	3,0	15,6		53	*
1,10	3,0	8,0		53		2,20	3,0	16,0		53	
1,15	3,0	8,3		53	*	2,25	3,0	16,3		53	*
1,20	3,0	8,7		53		2,30	3,0	16,7		53	
1,25	3,0	9,1		53	*	2,35	3,0	17,0		53	*
1,30	3,0	9,4		53		2,40	3,0	17,4		53	
1,35	3,0	9,8		53	*	2,45	3,0	17,8		53	*
1,40	3,0	10,2		53		2,50	3,0	18,1		53	
1,45	3,0	10,5		53	*	2,55	3,0	18,5		53	*
1,50	3,0	10,9		53		2,60	3,0	18,9		53	
1,55	3,0	11,2		53	*	2,65	3,0	19,2		53	*
1,60	3,0	11,6		53		2,70	3,0	19,6		53	
1,65	3,0	12,0		53	*	2,75	3,0	19,9		53	*
1,70	3,0	12,3		53		2,80	3,0	20,3		53	
1,75	3,0	12,7		53	*	2,85	3,0	20,7		53	*
1,80	3,0	13,1		53		2,90	3,0	21,0		53	
1,85	3,0	13,4		53	*	2,95	3,0	21,4		53	*
						3,00	3,0	21,8		53	

Disponibili su richiesta*
Min. 5 pz

Disponible sur demande*
Au moins 5 pièces

Available on request*
Minimum qty 5 pcs

Verfügbar auf Anfrage*
Mindestmenge 5 Stk

Punta pilota elicoidale, taglio destro, gambo rinforzato
Foret hélicoidal à haute performances, coupe à droite, queue renforcée
Hochleistung-Pilotbohrer, Rechtsschneidend, Verstärkter Schaft
High-performance pilot drill, right hand cutting, reinforced shank
高性能パイロットドリル, 右刃, 強化シャンク
高性能定心钻, 右旋切削, 增强柄

MTB27

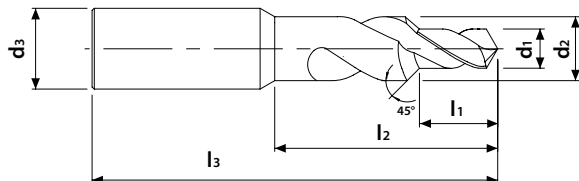

Campo d'impiego / Champ d'application / Einsatzbereich / Application field / 応用範囲 / 应用

HRC < 60	Inox Stainless	GG(G)/ghisa Ft/cast iron	Titanio Titan	ALU
----------	-------------------	-----------------------------	------------------	-----

d1	k5	d2	d3 h6	l1	l2	l3	d1	k5	d2	d3 h6	l1	l2	l3
0,80	2,0	3,0	1,6	4,8	53		1,90	3,0	3,0	3,8	8,6	53	
0,85	2,0	3,0	1,7	4,9	53	*	1,95	3,0	3,0	3,9	8,7	53	*
0,90	2,0	3,0	1,8	5,0	53		2,00	3,0	3,0	4,0	***	53	
0,95	2,0	3,0	1,9	5,1	53	*	2,05	3,2	4,0	4,1	10,8	53	*
1,00	2,2	3,0	2,0	5,5	53		2,10	3,2	4,0	4,2	10,9	53	
1,05	2,2	3,0	2,1	5,6	53	*	2,15	3,2	4,0	4,3	11,0	53	*
1,10	2,2	3,0	2,2	5,7	53		2,20	3,2	4,0	4,4	11,1	53	
1,15	2,2	3,0	2,3	5,8	53	*	2,25	3,4	4,0	4,5	11,6	53	*
1,20	2,2	3,0	2,4	5,9	53		2,30	3,4	4,0	4,6	11,7	53	
1,25	2,5	3,0	2,5	6,5	53	*	2,35	3,4	4,0	4,7	11,8	53	*
1,30	2,5	3,0	2,6	6,6	53		2,40	3,4	4,0	4,8	11,9	53	
1,35	2,5	3,0	2,7	6,7	53	*	2,45	3,6	4,0	4,9	12,5	53	*
1,40	2,5	3,0	2,8	6,8	53		2,50	3,6	4,0	5,0	12,6	53	
1,45	2,7	3,0	2,9	7,2	53	*	2,55	3,6	4,0	5,1	12,7	53	*
1,50	2,7	3,0	3,0	7,3	53		2,60	3,6	4,0	5,2	12,8	53	
1,55	2,7	3,0	3,1	7,4	53	*	2,65	3,8	4,0	5,3	13,3	53	*
1,60	2,7	3,0	3,2	7,5	53		2,70	3,8	4,0	5,4	13,4	53	
1,65	2,8	3,0	3,3	7,7	53	*	2,75	3,8	4,0	5,5	13,5	53	*
1,70	2,8	3,0	3,4	7,8	53		2,80	3,8	4,0	5,6	13,6	53	
1,75	2,8	3,0	3,5	7,9	53	*	2,85	4,0	4,0	5,7	13,9	53	*
1,80	2,8	3,0	3,6	8,0	53		2,90	4,0	4,0	5,8	14,0	53	
1,85	3,0	3,0	3,7	8,5	53	*	2,95	4,0	4,0	5,9	14,1	53	*
							3,00	4,0	4,0	6,0	***	53	

Disponibili su richiesta*
Min. 5 pz

Disponible sur demande*
Au moins 5 pièces

Available on request*
Minimum qty 5 pcs

Verfügbar auf Anfrage*
Mindestmenge 5 Stk

Parametri indicativi per la foratura con TUSA TOP DRILL
Standard values for drilling with TUSA TOP DRILL
Richtwerte für das Bohren mit TUSA TOP DRILL Spiralbohrer
Paramètres indicatifs pour le perçage avec TUSA TOP DRILL

Materiale Material Matière Werkstoff	Resistenza alla trazione Tensile strength Résistance à la traction Zugfestigkeit N/mm2	Diametro Diameter Diametre Durchmesser d (mm)	Avanzamento Feed Avance Vorschub (mm/ rev)	Velocità di taglio Cutting speed Vitesse de coupe Schnittgeschwindigkeit V (m/min)	Lubrificante Coolant Lubrifiant Kühlung
Acciai non legati (C<0,2%) <i>Non-alloyed steels (C<0,2%)</i> Aciers non alliés (C<0,2%) <i>Unlegierte Stähle (C<0,2%)</i>	fino a 800 <i>up to 800</i> jusqu'à 800 <i>bis 800</i>	1,0 1,2 1,5 2,0 2,5 3,0	< 0.11 <0.14 <0.18 <0.23 <0.25 <0.32	80 : 120	Olio da taglio <i>Cutting oil</i> Huile de coupe <i>Schneidöl</i>
Acciai debolmente legati <i>Light-Alloyed steels</i> Aciers faiblement alliés <i>Leicht-Legierte Stähle</i>	fino a 1000 <i>up to 1000</i> jusqu'à 1000 <i>bis 1000</i>	1,0 1,2 1,5 2,0 2,5 3,0	< 0.10 <0.14 <0.23 <0.25 <0.27 <0.32	60 : 100	Olio da taglio <i>Cutting oil</i> Huile de coupe <i>Schneidöl</i>
Acciai legati <i>Alloyed steels</i> Aciers alliés <i>Legierte Stähle</i>	fino a 1400 <i>up to 1400</i> jusqu'à 1400 <i>bis 1400</i>	1,0 1,2 1,5 2,0 2,5 3,0	< 0.07 <0.11 <0.14 <0.18 <0.21 <0.23	40 : 80	Olio da taglio <i>Cutting oil</i> Huile de coupe <i>Schneidöl</i>
Acciai per utensili <i>Die steels</i> Aciers pour outils <i>Werkzeugstahl</i>	fino a 1200 <i>up to 1200</i> jusqu'à 1200 <i>bis 1200</i>	1,0 1,2 1,5 2,0 2,5 3,0	< 0.11 <0.14 <0.18 <0.23 <0.25 <0.27	30 : 60	Olio da taglio <i>Cutting oil</i> Huile de coupe <i>Schneidöl</i>
Ghisa grigia/ Ghisa malleabile <i>Iron/ Malleable iron</i> Fonte/ Fonte malléable <i>Grauguss/ Temperguss</i>	fino a 300 HB <i>up to 300HB</i> jusqu'à 300HB <i>bis 300HB</i>	1,0 1,2 1,5 2,0 2,5 3,0	< 0.18 <0.23 <0.27 <0.32 <0.36 <0.41	80 : 150	Emulsione/olio <i>Emulsion/oil</i> Emulsion/ huile <i>Emulsion/Oel</i>



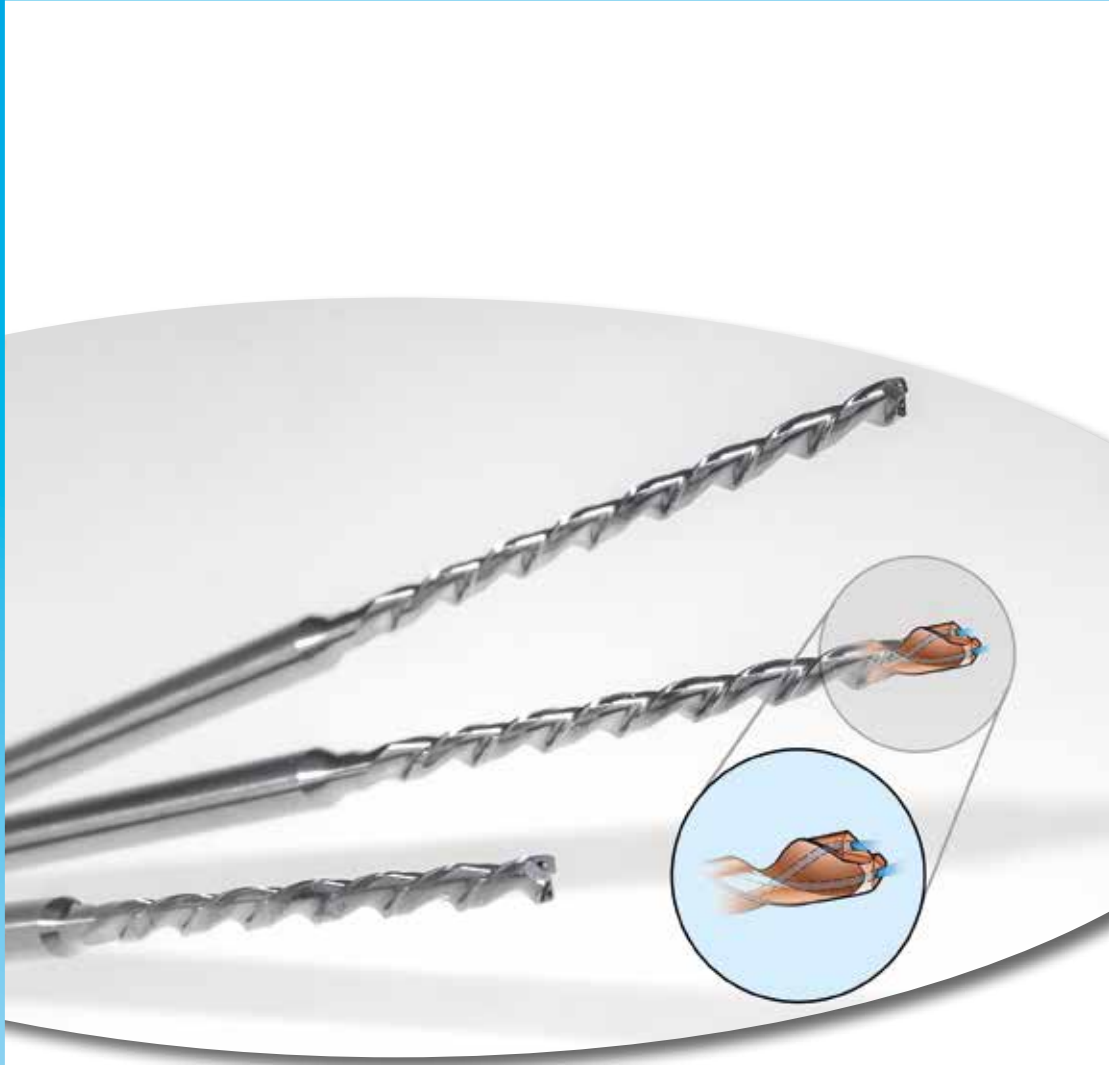

TUSA TOP DRILL

WITH COOLANT HOLES

TTD 204
TTD 209
TTD 215



Parametri indicativi per la foratura con TUSA TOP DRILL con canalini
Standard values for drilling with TUSA TOP DRILL with coolant holes
Richtswerte für das Bohren mit TUSA TOP DRILL mit Kühlkanälen
Paramètres indicatifs pour perçage avec TOP DRILL avec trous d'huile

Materiale Material Matière Werkstoff	Resistenza alla trazione Tensile strength Résistance à la traction Zugfestigkeit	Diametro Diameter Diametre Durchmesser	Avanzamento Feed Avance Vorschub	Velocità di taglio Cutting speed Vitesse de coupe Schnittgeschwindigkeit	Lubrificante Coolant Lubrifiant Kühlung
	N/mm2	d (mm)	(mm/ rev)	V (m/min)	
Acciai non legati (C<0,2%) <i>Non-alloyed steels (C<0,2%)</i> Aciers non alliés (C<0,2%) <i>Unlegierte Stähle (C<0,2%)</i>	fino a 800 <i>up to 800</i> jusqu'à 800 <i>bis 800</i>	1.00-1.50mm 1.60-2.00mm 2.10-2.50mm 2.60-3.00mm	0.05-0.07 0.08-0.10 0.10-0.14 0.15-0.18	45 : 75	Olio da taglio <i>Cutting oil</i> Huile de coupe <i>Schneidöl</i>
Acciai non legati (C<0,2%) <i>Non-alloyed steels (C<0,2%)</i> Aciers non alliés (C<0,2%) <i>Unlegierte Stähle (C<0,2%)</i>	800 - 1500 N/mm2	1.00-1.50mm 1.60-2.00mm 2.10-2.50mm 2.60-3.00mm	0.02-0.04 0.03-0.05 0.04-0.07 0.05-0.09	35 : 70	Olio da taglio <i>Cutting oil</i> Huile de coupe <i>Schneidöl</i>
Acciaio inossidabile <i>Stainless Steel</i> Aciers inoxydables <i>Rostfreier Stahl</i>	400 - 700 N/mm2	1.00-1.50mm 1.60-2.00mm 2.10-2.50mm 2.60-3.00mm	0.01-0.03 0.015-0.05 0.03-0.07 0.05-0.10	25 : 40	Olio da taglio <i>Cutting oil</i> Huile de coupe <i>Schneidöl</i>
Ghisa grigia/ Ghisa malleabile <i>Iron/ Malleable iron</i> Fonte/ Fonte malléable <i>Grauguss/ Temperguss</i>	< 250 HB	1.00-1.50mm 1.50-2.00mm 2.00-3.00mm 3.00-4.00mm	0.03-0.05 0.04-0.06 0.05-0.07 0.05-0.07	30 : 60	Olio da taglio <i>Cutting oil</i> Huile de coupe <i>Schneidöl</i>
Ghisa grigia/ Ghisa malleabile <i>Iron/ Malleable iron</i> Fonte/ Fonte malléable <i>Grauguss/ Temperguss</i>	> 250 HB	1.00-1.50mm 1.50-2.00mm 2.00-3.00mm 3.00-4.00mm	0.02-0.03 0.03-0.04 0.03-0.05 0.04-0.06	10:40	Olio da taglio <i>Cutting oil</i> Huile de coupe <i>Schneidöl</i>
Ghisa ferritica sferoidale <i>Ferritic Spheroidal Cast Iron</i> Fonte ferritique sphéroïdal <i>Ferritischer Sphäroguss</i>		1.00-1.50mm 1.50-2.00mm 2.00-3.00mm 3.00-4.00mm	0.03-0.04 0.04-0.05 0.04-0.05 0.06-0.07	15:40	Olio da taglio <i>Cutting oil</i> Huile de coupe <i>Schneidöl</i>
Titanio e lega di titanio <i>Titanium</i> Titane, alliage de titane <i>Titan, Titanlegierung</i>		1.00-1.50mm 1.60-2.00mm 2.10-2.50mm 2.60-3.00mm	0.02-0.04 0.03-0.05 0.04-0.07 0.05-0.09	10:30	Olio da taglio <i>Cutting oil</i> Huile de coupe <i>Schneidöl</i>



TUSA[®]

Precision Tools SA



MINIATUR

TA303B
MTB 43
MTB 44



SWISS MADE

Micropunta elicoidale con svasatura posteriore

Foret combiné avec chanfrein postérieur

Micro Bohr-Senk-Kombinationswerkzeug

Combination drill with back chamfer

裏面取りドリル

带后倒角复合钻头

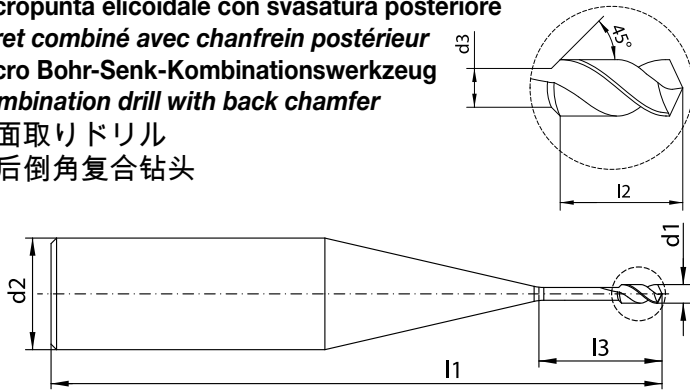

TA303B

SMG 10	Z 2
TUSA NORM	RH
MICRO	TiALN
	3xD

Campo d'impiego / Champ d'application / Einsatzbereich / Application field / 応用範囲 / 应用

HRC < 42	Inox Stainless	GG(G) / ghisa Ft / cast iron	Titanio Titan	ALU
----------	-------------------	---------------------------------	------------------	-----

d1 h5	d2 h6	d3	l1	l2	l3	d1 h5	d2 h6	d3	l1	l2	l3
0,50	3,00	0,34	50,00	1,50	3,00	1,80	4,00	1,21	60,00	5,40	10,80
0,60	3,00	0,40	50,00	1,80	3,60	1,90	4,00	1,27	60,00	5,70	11,40
0,70	3,00	0,47	50,00	2,10	4,20	2,00	4,00	1,34	60,00	6,00	12,00
0,80	3,00	0,54	50,00	2,40	4,80	2,10	6,00	1,41	70,00	6,30	12,60
0,90	3,00	0,60	50,00	2,70	5,40	2,20	6,00	1,47	70,00	6,60	13,20
1,00	3,00	0,67	50,00	3,00	6,00	2,30	6,00	1,54	70,00	6,90	13,80
1,10	3,00	0,74	50,00	3,30	6,60	2,40	6,00	1,61	70,00	7,20	14,40
1,20	3,00	0,80	50,00	3,60	7,20	2,50	6,00	1,68	70,00	7,50	15,00
1,30	3,00	0,87	50,00	3,90	7,80	2,60	6,00	1,74	70,00	7,80	15,60
1,40	3,00	0,94	50,00	4,20	8,40	2,70	6,00	1,81	70,00	8,10	16,20
1,50	3,00	1,01	50,00	4,50	9,00	2,80	6,00	1,88	70,00	8,40	16,80
1,60	4,00	1,07	60,00	4,80	9,60	2,90	6,00	1,94	70,00	8,70	17,40
1,70	4,00	1,14	60,00	5,10	10,20	3,00	6,00	2,01	70,00	9,00	18,00

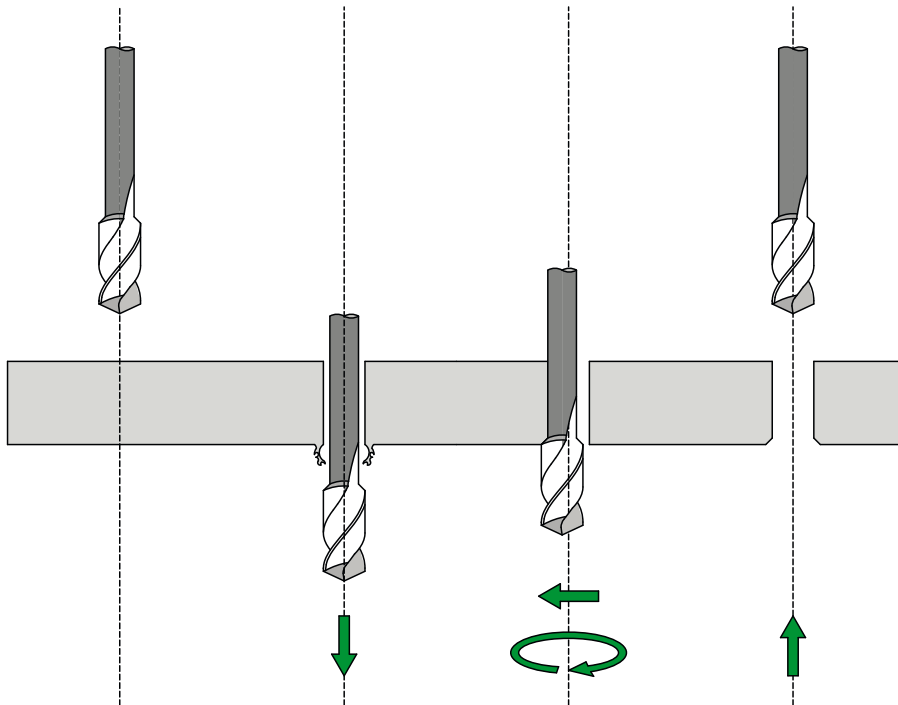



Zona industriale 2
CH-6805 MEZZOVICO-SWITZERLAND
Tel. +41 91 935 97 70
Fax +41 91 935 97 71
e-mail: info@tusa-precision.ch
www.tusa-precision.ch