

Electronic Length Measuring Equipment

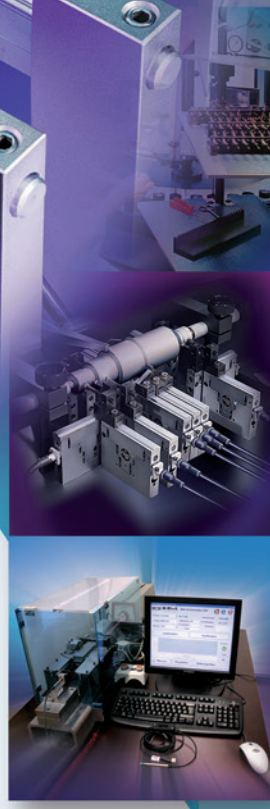

TESA INDUCTIVE PROBES AND ELECTRONIC EQUIPMENT

TESA probes: At the cutting edge of technology

TESA develops, manufactures and remains a leader in the inductive probe sector with an experience of more than 40 years. It offers a complete and unique line of probes designed to meet the requirements of varied as well as demanding applications.

Dimensional inspection of medium and large batches of parts in multigauging fixtures represents a major application area where measuring speed coupled with a high level of accuracy is needed.

High precision inductive probes (type GTL-21 HP) are, for example, also suited for the measurement of gauge blocks. The display resolution can reach a digital step of 0,01 μm !

On request, TESA probes can be supplied in versions compatible with the electronic equipment of other suppliers.

Typical qualities of TESA inductive probes : excellent repeatability, durability and longevity

All TESA inductive axial movement are mounted on a ball bearing with the exception of miniature models.

The ball bearing guidance system is insensitive to any radial force exerted on the probe housing. An anti-rotation guiding system ensures perfect movement of the mechanical guide.

The axial probe guide system is effectively protected against penetration of liquids (oils) or solids (dust) by sealing bellows of high elastic quality. Under normal conditions, the standard nitrile elastomer bellows provide sufficient protection against oils and solvents. For applications where the probes remain in prolonged contact with coolants or lubricants and aggressive chemicals, Viton bellows are recommended. Viton is a fluorelastomer resistant to the heat of oils and aggressive chemicals.

The retraction (lifting) of the measuring bolt rod can be made by the suction of air (vacuum) accumulated within the probe thanks to the airtightness provided by the sealing bellows. This method of working principle does not use any mechanical device ensures the operation of the guidance system in an optimal manner. Similarly, the probe can be moved into its measuring position by a pneumatic activation (pressure), depending on the probe model.

Inserts (measuring inserts) can be replaced or exchanged. A wide choice of geometrical forms and sizes are available

The measuring force can be adjusted by changing the spring, depending on the probe model.

The probes integrate an electronic amplifier of the signal without relying on any mechanical conversion device. Thus, these probes are distinguished by their high repeatability and very low hysteresis errors.

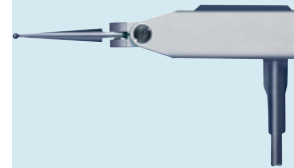
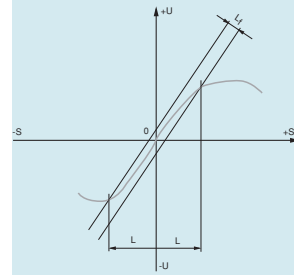

GT-31

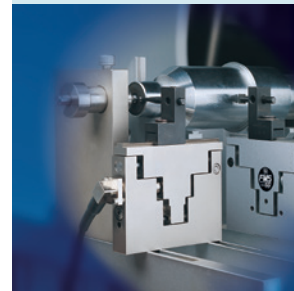

Probe FMS



TT20



USB probe



Wireless probe



Application examples of measuring functions

Measuring external dimensions with use of a measuring stand, snap gauge etc.

Single measurements with positive polarity sign (+A)

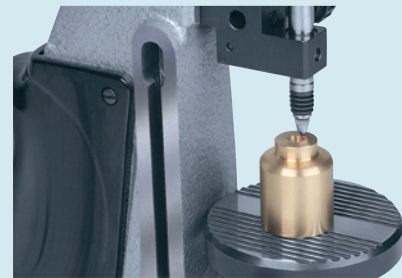
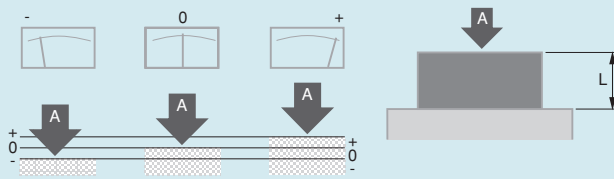

Inversion of polarity with displayed value equal to bore or diameter

Single measurements with negative polarity sign (-A)

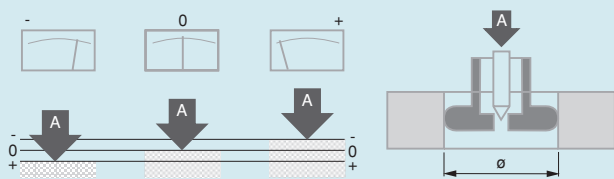

Measuring external dimensions regardless of form and position errors

Sum measurements with positive polarity signs (+A +B)

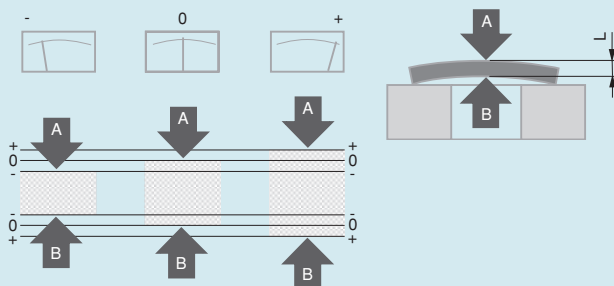

Cone, inclination and step measurements.

Difference measurements with opposite polarity signs (+A -B)

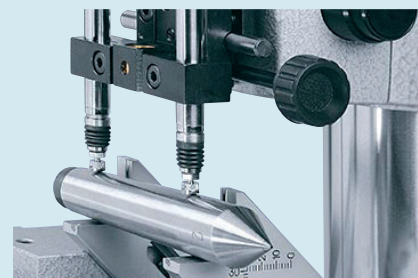
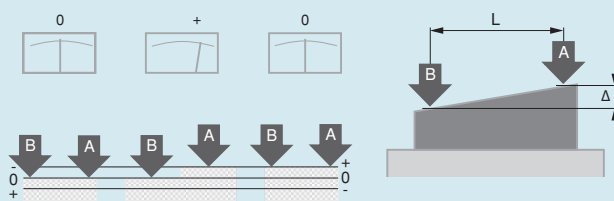

Establishing form and position errors with "max - min" memory function as in the example for runout errors

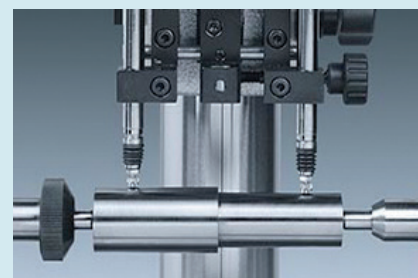
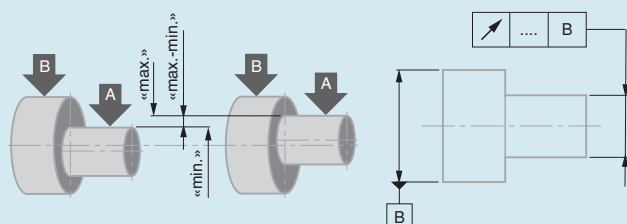

For the acquisition of measured values, TESA offers a complete family of probes and measuring instruments for the most demanding applications. The probes, supplied in standard execution, do not need any form of adaptation. They function on the inductive half-bridge principle.

The market offers other equipment using probes that partly operate on the principle of a differential transformer and these are known as LVDT (Linear Variable Differential Transformer) probes.

TESA also offers a range of probes compatible with other electronic equipment, using an adaptor and a connector depending on the origin of the equipment. A description of TESA standard half-bridge and LVDT probes is provided below.

Standard half-bridge probes for TESA equipment

OPERATING PRINCIPLE

All TESA electronic probes (value sensors) work based on the inductive principle with mechanical contact of the workpiece.

They are fitted with a coil system inducing an alternating output voltage that depends on the the position of the ferro magnetic core. When symmetrically positioned – i.e. at electrical zero – no voltage is impressed. A move of the core, which may be attached to the measuring bolt while the measurand is being taken, causes the inductance to change. This change generates a signal that is amplified and rectified before being displayed and further output. Depending on the instrument type, the analogue signal will be shown on a voltmeter or a numerical display after a digital transformation.

Unambiguous assessment of the measurand (at bolt position) to the signal (displayed value) is the main characteristic of analogue value acquisition. One of its distinct advantages lies in the value primarily displayed, which will be reproduced in the event of a power cut (switch-off or power failure).

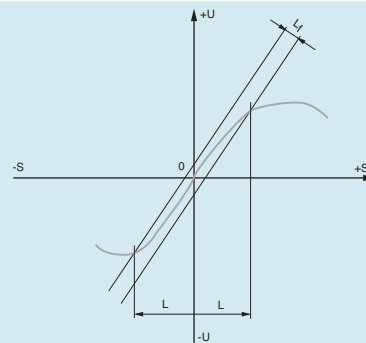

Inductive measuring
 S: Travel
 U: Output current
 0: Electrical zero
 L: Linearity range
 Lf: Linearity error

TESA Standard Half-Bridge Probes for TESA Electronic Equipment

These probes have two serial coils with middle output mounted side by side, which are energized by a sinusoidal alternation signal at 13 kHz. Both are linked together to a Wheatstone bridge over an additional half-bridge.

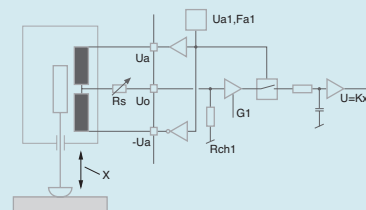

Wiring plan of half-bridge probes

TESA LVDT Probes

These probes are based on a Linear Variable Differential Transformer (LVDT). They have three coils, i.e. one primary coil being energized by a sinusoidal alternation at 5 kHz, and two secondary coils connected in opposite phase, which generate the output current proportional to the measuring travel.

Available upon request.

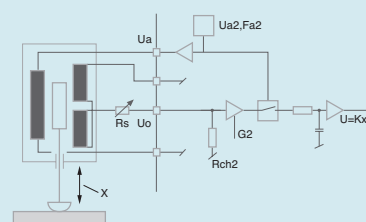

Wiring plan of LVDT probes



Multiple application possibilities

TESA probes have been designed for applications for use with instruments for internal and external measurements, measuring supports or special measuring systems. For such applications, different probe executions can be supplied such as probes with an axial measuring bolt or parallel guides, refer also to angle lever probes. In addition, there are also special executions developed for multi-gauging inspection fixtures or 'in-process' inspection stations, which enable an economy in the number of components needed. Apart from a few exceptions, the measuring operations executed are always comparative measurements with reference to a standard such as a gauge block, a setting ring or any other component that can be used as a master.

The measurements are extremely accurate. Bias error influence is negligible compared to the budget for measuring uncertainty given the fact that the comparison is being established between two almost practically equal values

Random errors also lose their influence in a procedure where the display setting is made under the same conditions as the subsequent probing measurements

TESA measuring instruments are equipped with an analogue and/or digital display, depending on the model.

Internal processing of measured values

Depending on the application, the electrical signals are processed in different ways within the instrument.

Mathematical Data Processing

The signals can be processed with positive polarity sign as well as negative polarity sign. The use of a single probe enables single measurement of internal or external dimensions while the combination of the signals of two probes produces either a "sum measurement" or a "difference measurement".

Value Storage

The storage of measured values in the memory ensures the reliability of dynamic measuring cycles. The characteristic values are the two minimum and maximum values or the difference between the smallest and largest value acquired while measuring form or position errors.

Classification of Values

The measured values can be classified after the entering of limit deviations. In this case, the control signals can be used by an external peripheral unit.

Components of a TESA inductive probe

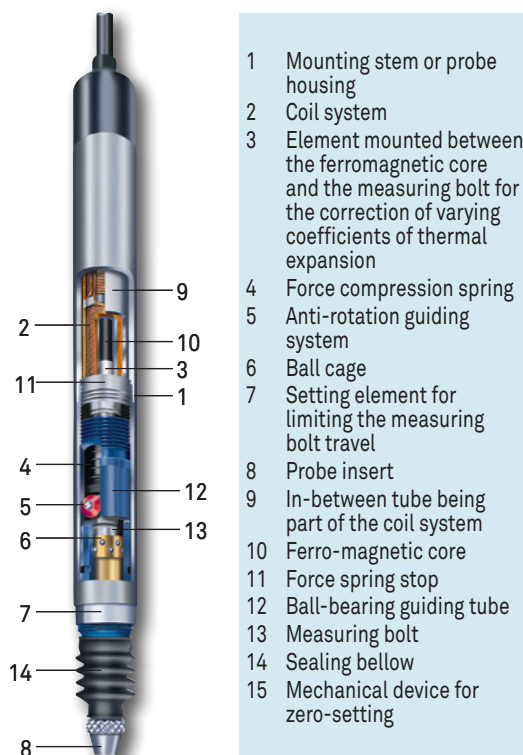

Sensitivity of TESA half-bridge probes for TESA electronic interfaces and electronic displays

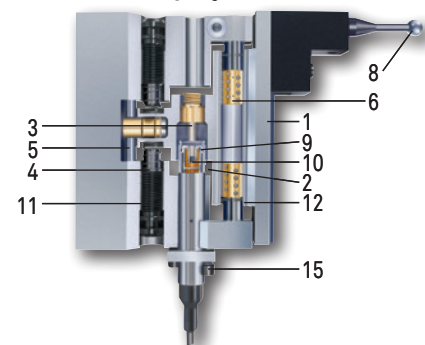

Sensitivity	73,75 mV/V/mm
	29,50 mV/V/mm (GT 61, GT 62)
	7,375 mV/V/mm (GT 61S, GT 62S)
	49,17 mV/V/mm (FMS 130, FMS 132)
All given values are valid for the following reference conditions :	
Drive voltage	3 V
Drive frequency	13 kHz
Adjustment load	2 kΩ









Probes with Axial Movement, Ø 8 mm

							
			Measuring range, mm	Measuring bolt travel, mm	Cable output	Measuring bolt retraction	Sealing bellows
	03210904	GT 21	± 1 mm	4,3	Axial	Mechanical	Nitrile
	03210924	GT 22	± 1 mm	4,3	Radial	Mechanical or vacuum	Nitrile
	03230057	GTL 21	± 2 mm	4,3	Axial	Mechanical	Viton
	03230072	GTL 211	± 2 mm	4,3	Axial	Vacuum	Viton
	03230056	GTL 22	± 2 mm	4,3	Radial	Vacuum	Viton
	03230027	GT 27	± 2 mm	10,3	Axial	Mechanical	Viton
	03230073	GT 271	± 2 mm	10,3	Axial	Mechanical / vacuum	Viton
	03230026	GT 28	± 2 mm	10,3	Radial	Mechanical / vacuum	Viton
	03230041	GT 61	± 5 mm	10,3	Axial	Mechanical	Viton
	03230042	GT 62	± 5 mm	10,3	Radial	Mechanical / vacuum	Viton
	03230036	GT 21 HP	± 0,2 mm	4,3	Axial	Mechanical	Nitrile
	03230021	GT 22 HP	± 0,2 mm	4,3	Radial	Mechanical or vacuum	Nitrile



* Nominal value of the measuring force at electrical zero, max. deviation $\pm 25\%$

** For an amplitude of 10 % to the last value of the measuring range

 Nominal measuring force*, N	 Mobile weight, g	 Mechanical limit max frequency** (Hz)	 Partially removable	 Répeatability, μm	 Max. permissible error for deviations in linearity, μm (L in mm)	 Hysteresis, μm	 Protection level (IP XX), as per IEC 60529
0,63	6	60	Yes	0,01 μm	$0,2 + 3 \cdot L^3 \mu\text{m}$	0,02	IP65
0,63	6	60	Yes	0,01 μm	$0,2 + 3 \cdot L^3 \mu\text{m}$	0,02	IP65
0,63	6	60	Yes	0,01 μm	$0,2 + 2,4 \cdot L^2 \mu\text{m}$ BPX: $0,2 + 0,8 \cdot L \mu\text{m}$	0,02	IP65
0,63	6	60	Yes	0,01 μm	$0,2 + 2,4 \cdot L^2 \mu\text{m}$ BPX: $0,2 + 0,8 \cdot L \mu\text{m}$	0,02	IP65
0,63	6	60	Yes	0,01 μm	$0,2 + 2,4 \cdot L^2 \mu\text{m}$ BPX: $0,2 + 0,8 \cdot L \mu\text{m}$	0,02	IP65
0,63	8	60	Yes	0,05 μm	$0,2 + 3 \cdot L^3 \mu\text{m}$	0,05	IP65
0,63	8	60	Yes	0,05 μm	$0,2 + 3 \cdot L^3 \mu\text{m}$	0,05	IP65
0,63	8	60	Yes	0,05 μm	$0,2 + 3 \cdot L^3 \mu\text{m}$	0,05	IP65
0,90	8	60	Yes	0,05 μm	$1 + 4 \cdot L \mu\text{m}$ BPX: $0,6 + 0,8 \cdot L \mu\text{m}$	0,05	IP65
0,90	8	60	Yes	0,05 μm	$1 + 4 \cdot L \mu\text{m}$ BPX: $0,6 + 0,8 \cdot L \mu\text{m}$	0,05	IP65
0,63	6	60	No	0,01 μm	$0,07 + 0,4 \cdot L \mu\text{m}$	0,01	IP64
0,63	6	60	No	0,01 μm	$0,07 + 0,4 \cdot L \mu\text{m}$	0,01	IP64











Probes with Axial Movement, Ø 8 mm, with Activation of the Measuring Bolt by Pneumatic Pressure

						
			Measuring range, mm	Measuring bolt travel, mm	Cable output	Sealing bellows
	03230060	GTL 212	± 1,5 mm	3,2	Axial	Viton
	03230054	GTL 222	± 1,5 mm	3,2	Radial	Viton
	03230067	GTL 212-A	± 1,5 mm	3,2	Axial	Without bellows
	03230063	GTL 222-A	± 1,5 mm	3,2	Radial	Without bellows
	03230061	GT 272	± 2 mm	10,3	Axial	Viton
	03230053	GT 282	± 2 mm	10,3	Radial	Viton
	03230068	GT 272-A	± 2 mm	10,3	Axial	Without bellows
	03230069	GT 282-A	± 2 mm	10,3	Radial	Without bellows
	03230062	GT 612	± 5 mm	10,3	Axial	Viton
	03230055	GT 622	± 5 mm	10,3	Radial	Viton
	03230070	GT 612-A	± 5 mm	10,3	Axial	Without bellows
	03230071	GT 622-A	± 5 mm	10,3	Radial	Without bellows



* Nominal value of the measuring force at electrical zero, max. deviation $\pm 25\%$

** For an amplitude of 10% to the last value of the measuring range

 Measuring force, nominal*, N	 Mobile weight, g	 Max. mechanical frequency limit** (Hz)	 Partially removable	 Repeatability, μm	 Max. permissible error for deviations in linearity, μm (L in mm)	 Hysteresis, μm	 Protection level (IP XX), as per IEC 60529
1,2	6	60	Yes	0,015 μm	$0,2 + 2,4 \cdot L^2 \mu\text{m}$ BPX: $0,2 + 0,8 \cdot L \mu\text{m}$	0,02	IP65
1,2	6	60	Yes	0,015 μm	$0,2 + 2,4 \cdot L^2 \mu\text{m}$ BPX: $0,2 + 0,8 \cdot L \mu\text{m}$	0,02	IP65
0,2	6	60	Yes	0,015 μm	$0,2 + 2,4 \cdot L^2 \mu\text{m}$ BPX: $0,2 + 0,8 \cdot L \mu\text{m}$	0,02	IP50
0,2	6	60	Yes	0,015 μm	$0,2 + 2,4 \cdot L^2 \mu\text{m}$ BPX: $0,2 + 0,8 \cdot L \mu\text{m}$	0,02	IP50
1,0	8	60	Yes	0,05 μm	$0,2 + 3 \cdot L^3 \mu\text{m}$	0,05	IP65
1,0	8	60	Yes	0,05 μm	$0,2 + 3 \cdot L^3 \mu\text{m}$	0,05	IP65
0,85	8	60	Yes	0,05 μm	$0,2 + 3 \cdot L^3 \mu\text{m}$	0,05	IP50
0,85	8	60	Yes	0,05 μm	$0,2 + 3 \cdot L^3 \mu\text{m}$	0,05	IP50
2,0	8	60	Yes	0,05 μm	$1 + 4 \cdot L \mu\text{m}$ BPX: $0,6 + 0,8 \cdot L \mu\text{m}$	0,05	IP65
2,0	8	60	Yes	0,05 μm	$1 + 4 \cdot L \mu\text{m}$ BPX: $0,6 + 0,8 \cdot L \mu\text{m}$	0,05	IP65
1,0	8	60	Yes	0,05 μm	$1 + 4 \cdot L \mu\text{m}$ BPX: $0,6 + 0,8 \cdot L \mu\text{m}$	0,05	IP50
1,0	8	60	Yes	0,05 μm	$1 + 4 \cdot L \mu\text{m}$ BPX: $0,6 + 0,8 \cdot L \mu\text{m}$	0,05	IP50











USB, DC, Wireless Probes

							
			Measuring range, mm	Max. plunger travel, mm	Cable output	Bolt retraction	Sealing bellows
	03230500	GTL 21 W	± 2 mm	4,3	Without cable	Mechanical	Viton
	03230502	GT61 W	± 5 mm	10,3	Without cable	Mechanical	Viton
	03230501	GTL 212 W	± 1,5 mm	4,3	Without cable	Pressure (bolt activation), below spring (bolt retraction)	Viton
	03230503	GT 612 W	± 5 mm	10,3	Without cable	Pressure (bolt activation), below spring (bolt retraction)	Viton
	03230201	GTL 22 USB	± 2 mm	4,3	Radial	Mechanical	Viton
	03230200	GTL 21 USB	± 2 mm	4,3	Axial	Mechanical	Viton
	03230204	GT 61 USB	± 5 mm	10,3	Axial	Mechanical	Viton
	03230205	GT 62 USB	± 5 mm	10,3	Radial	Mechanical / vacuum	Viton
	03230202	GTL 222 USB	± 1,5 mm	3,1	Radial	Pressure (bolt activation), below spring (bolt retraction)	Viton
	03230058	GTL 22 DC	± 2 mm	4,3	Radial	Mechanical / vacuum	Viton
	03230059	GTL 21 DC	± 2 mm	4,3	Axial	Mechanical	Viton
	03230087	GT 62 DC	± 5 mm	10,3	Radial	Mechanical / vacuum	Viton
	03230086	GT 61 DC	± 5 mm	10,3	Axial	Mechanical	Viton
	03230085	GT 44 DC	± 1 mm	2,1	Radial	Mechanical / vacuum	Viton
	03230081	GT 31 DC	± 0,3 mm	0,7	Angled	Without retraction	Without bellows













* Nominal value of the measuring force at electrical zero, max. deviation $\pm 25\%$

** For an amplitude of 10% to the last value of the measuring range



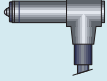

 Nominal measuring force*, N	 Mobile weight, g	 Max. mechanical frequency limit**, (Hz)	 Partially removable	 Repeatability, μm	 Maximum permissible error, μm (L in mm)	 Hysteresis, μm	 Level of protection (IP XX), as per IEC 60529
0,63	6	60	No	0,10 μm	$0,4 + 0,8 \cdot L \mu\text{m}$	0,5	IP54
0,9	8	60	No	0,24 μm	$0,8 + 0,8 \cdot L \mu\text{m}$	0,5	IP54
1,2	6	60	No	0,10 μm	$0,4 + 0,8 \cdot L \mu\text{m}$	0,5	IP54
2,0	8	60	No	0,24 μm	$0,8 + 0,8 \cdot L \mu\text{m}$	0,5	IP54
0,63	6	60	No	0,1 μm	$0,4 + 0,8 \cdot L \mu\text{m}$	0,5	IP65
0,63	6	60	No	0,1 μm	$0,4 + 0,8 \cdot L \mu\text{m}$	0,5	IP65
0,90	8	60	No	0,24 μm	$0,8 + 0,8 \cdot L \mu\text{m}$	0,5	IP65
0,90	8	60	No	0,24 μm	$0,8 + 0,8 \cdot L \mu\text{m}$	0,5	IP65
1,2	6	60	No	0,1 μm	$0,4 + 0,8 \cdot L \mu\text{m}$	0,5	IP64
0,63	6	60	Yes	0,1 μm	$0,2 + 3,5 \cdot L^2 \mu\text{m}$		IP65
0,63	6	60	Yes	0,1 μm	$0,2 + 3,5 \cdot L^2 \mu\text{m}$		IP65
0,9	8	60	No	0,1 μm	$1 + 4 \cdot L \mu\text{m}$		IP65
0,9	8	60	Yes	0,1 μm	$1 + 4 \cdot L \mu\text{m}$		IP65
0,4	2	60	No	0,1 μm	$0,2 + 5 \cdot L^2 \mu\text{m}$		IP65
0,1	12	25	No	0,1 μm	$0,2 + 50 \cdot L^2 \mu\text{m}$		IP50



Probes with Axial Movement, $\varnothing 8$ mm

							
			Measuring range, mm	Measuring bolt travel, mm	Cable output	Bolt retraction	Sealing bellows
	03230001	GT 41	$\pm 0,3$ mm	0,7	Axial	None	Nitrile
	03230002	GT 42	$\pm 0,3$ mm	0,7	Radial	Vacuum	Nitrile
	03230035	GT 43	± 1 mm	2,1	Axial	Mechanical	Viton
	03230017	GT 44	± 1 mm	2,1	Radial	Vacuum	Viton

Unbranded Axial Probes with Measuring Bolt Mounted on a Ball-bearing

	96410012	410	± 1 mm	2,5	Axial and radial	Mechanical	Nitrile
	96160013	160	± 1 mm	3,3	Axial	Mechanical	Viton
	96430029	430	$\pm 0,5$ mm	1,25	Axial	Mechanical	Nitrile
	96441041	451	$\pm 0,5$ mm	2,10	Radial	Mechanical	Nitrile



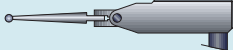





Probe with Inclinable Lever

	03210802	GT 31	$\pm 0,3$ mm	0,7	Angled	Without	Without bellows
---	----------	-------	--------------	-----	--------	---------	-----------------



* Nominal value of the measuring force at electrical zero, max. deviation $\pm 25\%$

** For an amplitude of 10 % to the last value of the measuring range

 Nominal measuring force*, N	 Mobile weight, g	 Max. mechanical frequency limit**, (Hz)	 Partially removable	 Repeatability, μm	 Max. permissible error for deviations in linearity, μm (L en mm)	 Hysteresis, μm	 Level of protection (IP XX), as per IEC 60529
0,63	2	60	No	0,01 μm	$0,2 + 5 \cdot L^2 \mu\text{m}$	0,01	IP65
0,63	2	60	No	0,01 μm	$0,2 + 5 \cdot L^2 \mu\text{m}$	0,01	IP65
0,4	2	60	No	0,1 μm	$0,2 + 5 \cdot L^2 \mu\text{m}$	0,15	IP65
0,4	2	60	No	0,1 μm	$0,2 + 5 \cdot L^2 \mu\text{m}$	0,15	IP65

0,60	3,1	60	No	0,1 μm	0,2 % (for a measuring span of ± 1 mm) μm		IP62
0,60	2,5	60	No	0,1 μm	0,2 % (for a measuring span of ± 1 mm) μm		IP62
0,75	1,9	60	No	0,2 μm	0,2 % (for a measuring span of $\pm 0,5$ mm) μm		IP62
0,60	3,0	60	No	0,1 μm	0,2 % (for a measuring span of $\pm 0,5$ mm) μm		IP62

0,1	12	25	No	0,1 μm	$0,2 + 50 \cdot L^2 \mu\text{m}$	0,25	IP40
-----	----	----	----	-------------------	----------------------------------	------	------











Universal FMS Probes

			 Measuring range, mm	 Measuring bolt travel, mm	 Cable output	 Bolt retraction	 Sealing bellows
	03230019	FMS 100	± 2 mm	5,8	Parallel	Retraction by air pressure (optional)	Without bellows
	03230049	FMS 130	± 2,9 mm	5,8	Parallel	Retraction by air pressure (optional)	Without bellows
	03230028	FMS 102	± 2 mm	5,8	Parallel	Retraction by air pressure (optional)	Without bellows
	03230050	FMS 132	± 2,9 mm	5,8	Parallel	Retraction by air pressure (optional)	Without bellows
	03230037	FMS100-P	± 2 mm	5,8	Parallel	Retraction by air pressure (optional)	Without bellows
	03230051	FMS130-P	± 2,9 mm	5,8	Parallel	Retraction by air pressure (optional)	Without bellows
	03230038	FMS102-P	± 2 mm	5,8	Angled	Retraction through air pressure (optional)	Without bellows
	03230052	FMS132-P	± 2,9 mm	5,8	Angled	Retraction through air pressure (optional)	Without bellows



* Nominal value of the measuring force at electrical zero, max. deviation $\pm 25\%$

** For an amplitude of 10% to the last value of the measuring range

 Nominal measuring force*, N	 Mobile weight, g	 Max. mechanical frequency limit**, Hz	 Partially removable	 Repeatability, μm	 Max. permissible error for deviation in linearity, μm (L in mm)	 Hysteresis, μm	 Protection level (IP XX), as per IEC 60529
2	110	25	Yes	0,5 μm	0,2 + 3 · L ³ μm	0,5	IP50
2	110	25	Yes	0,5 μm	0,2 + 3 · L ³ μm	0,5	IP50
2	110	25	Yes	0,5 μm	0,2 + 3 · L ³ μm	0,5	IP50
2	110	25	Yes	0,5 μm	0,2 + 3 · L ³ μm	0,5	IP50
2	110	25	Yes	0,5 μm	0,2 + 3 · L ³ μm	0,5	IP54
2	110	25	Yes	0,5 μm	0,2 + 3 · L ³ μm	0,5	IP54
2	110	25	Yes	0,5 μm	0,2 + 3 · L ³ μm	0,5	IP54
2	110	25	Yes	0,5 μm	0,2 + 3 · L ³ μm	0,5	IP54



Standard Probes, ± 1 mm, 4,3 mm Travel (GT21)

Universal probes for standard and continuous use applications.

- 8 mm diameter probe housing. Can be clamped over its entire length.
- Measuring bolt mounted on a ball bearing.
- Both the probe housing and ball-bearing guide are separate from one another, so that the measuring bolt moves easily even if the probe is not clamped appropriately.
- Degree of protection IP65 according to IEC 60529.
- Wide range of accessories including measuring inserts, spring sets, etc.
- LVDT probes compatible with measuring equipment from other makers available on request.



GT21

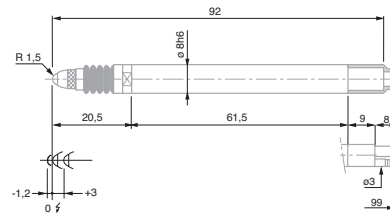

GT 21

No	=	Measuring range, mm	Nominal measuring force*, N	Measuring bolt retraction	Sealing bellows
03210904	GT 21	± 1	0,63	Mechanical	Nitrile
03210905	GT 21	± 1	1,00	Mechanical	Nitrile
03210906	GT 21	± 1	1,60	Mechanical	Nitrile
03210907	GT 21	± 1	2,50	Mechanical	Nitrile
03210908	GT 21	± 1	4,00	Mechanical	Nitrile

	=	Measuring bolt travel, mm	Max. permissible error for deviations in linearity, µm (L in mm)	Repeatability, µm	Hysteresis, µm	Setting of the lower bolt stop***, mm (factory setting)	Cable output	Data Sheet No.
GT 21	4,3	0,2 + 3 · L ³	0,01	0,02	-2,2 to 0,1 (factory setting -1,2)	Axial	03200249	

* Electrical zero (N) ± 25 % deviation limit. Valid in vertical mounting position, measuring bolt lowered and in static measuring.

** For an amplitude of 10 % to the last value of the measuring range.

*** Distance from electrical zero.



DIN 32876 Part 1



See table



Nickel-plated housing. Stainless steel measuring bolt, hardened. Nitrile sealing bellows = resistant elastomer



Fixing shank Ø 8 mm. Measuring bolt guided on ball-bearing. Distance from electrical zero of both stops is either adjustable (downward) or depending on the position of the lower stop (upward). Interchangeable inserts. M2,5 thread. Carbide ball tip Ø 3 mm. 2 m long cable. 5-pin DIN 45322 connector.



Supply frequency: 13 kHz (± 5 %). Max mechanical frequency** 60 Hz.



0,15 µm/°C



20 ± 0,5°C



-10°C to 65°C



80 %



Protection level IP65 (IEC 60529)



Mobile weight: 6 g



Transport packaging



Identification number



Inspection report with a declaration of conformity



Standard Probes, ± 1 mm, 4,3 mm Travel (GT22)

Universal probes for common but constraining applications.

- 8 mm diameter probe housing. Can be clamped over its entire length.
- Measuring bolt mounted on a ball bearing.
- Both the probe housing and ball-bearing guide are separate from one another, so that the measuring bolt moves easily even if the probe is not clamped appropriately.
- Degree of protection IP65 according to IEC 60529.
- Wide range of accessories including measuring inserts, spring sets, etc.
- LVDT probes compatible with measuring equipment from other makers available on request.

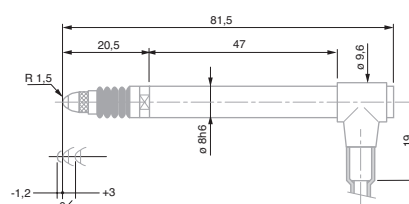

GT 22

GT 22



DIN 32876 Part 1



See table



Nickel-plated housing. Stainless steel measuring bolt, hardened. Nitrile sealing bellows = resistant elastomer



Fixing shank Ø 8 mm. Measuring bolt guided on ball-bearing. Distance from electrical zero of both stops is either adjustable (downward) or depending on the position of the lower stop (upward). Interchangeable inserts. M2,5 thread. Carbide ball tip Ø 3 mm. 2 m long cable. 5-pin DIN 45322 connector.



Supply frequency: 13 kHz (± 5 %). Max mechanical frequency** 60 Hz.



0,15 µm/°C



20 ± 0,5°C



-10°C to 65°C



80 %



Protection level IP65 (IEC 60529)



Mobile weight: 6 g



Transport packaging



Identification number



Inspection report with a declaration of conformity

		Measuring range, mm	Nominal measuring force*, N	Measuring bolt retraction	Sealing bellows
03210924	GT 22	± 1	0,63	Mechanical or vacuum	Nitrile
03210921	GT 22	± 1	0,16	Mechanical or vacuum	Nitrile
03210922	GT 22	± 1	0,25	Mechanical or vacuum	Nitrile
03210923	GT 22	± 1	0,40	Mechanical or vacuum	Nitrile
03210925	GT 22	± 1	1,00	Mechanical	Nitrile
03210926	GT 22	± 1	1,60	Mechanical	Nitrile
03210927	GT 22	± 1	2,50	Mechanical	Nitrile
03210928	GT 22	± 1	4,00	Mechanical	Nitrile

	Measuring travel, mm	Max. permissible error for deviations in linearity, µm (L in mm)	Repeatability, µm	Hysteresis, µm	Setting of the lower bolt stop***, mm (factory setting)	Cable output	Data Sheet No.
GT 22	4,3	0,2 + 3 · L ³	0,01	0,02	-2,2 to 0,1 (factory setting -1,2)	Radial	03200250

* Electrical zero (N) ± 25 % deviation limit. Valid in vertical mounting position, measuring bolt lowered and in static measuring.

** For an amplitude of 10 % to the last value of the measuring range.

*** Distance from electrical zero.



Standard Probes ± 2 mm, 4,3mm Bolt Travel, Linear Travel

Universal probes for standard and continual usage applications.

- Probe housing Ø 8 mm with possibility of clamping over its entire length.
- Measuring bolt mounted on a ball bearing.
- Both the probe housing and ball-bearing guide are separate from one another, so that the measuring bolt moves easily even if the probe is not clamped appropriately.
- Degree of protection IP65 according to IEC 60529.
- Wide range of accessories including measuring inserts, spring sets, etc.
- LVDT probes compatible with measuring equipment from other makers available on request.

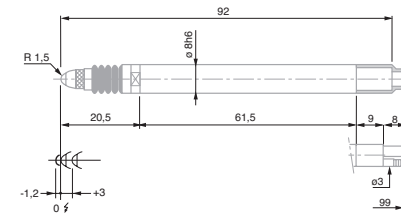

GTL 21
GTL 211

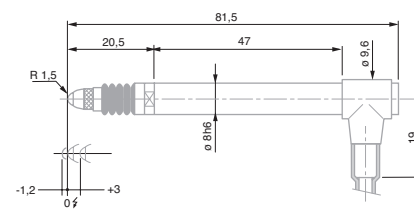

GTL 22



GTL 21
GTL 211



GTL 22

No	=	Measuring range, mm	Nominal measuring force*, N	Measuring bolt retraction	Sealing bellows
03230057	GTL 21	± 2	0,63	Mechanical	Viton
03230072	GTL 211	± 2	0,63	Vacuum	Viton
03230056	GTL 22	± 2	0,63	Vacuum	Viton

	Measuring bolt travel, mm	Max. permissible error for deviation in linearity, µm (L in mm)	Repeatability, µm	Hysteresis, µm	Setting of measuring bolt lower stop***, mm (factory setting)	Cable output	Data Sheet No.
GTL 21	4,3	0,2 + 2,4 · L ² (BPX: 0,2 + 0,8 · L)	0,01	0,02	-2,2 to 0,1 (factory setting -1,2)	Axial	03200391
GTL 211	4,3	0,2 + 2,4 · L ² (BPX: 0,2 + 0,8 · L)	0,01	0,02	-2,2 to 0,1 (factory setting -1,2)	Axial	03200435
GTL 22	4,3	0,2 + 2,4 · L ² (BPX: 0,2 + 0,8 · L)	0,01	0,02	-2,2 to 0,1 (factory setting -1,2)	Radial	03200392

* Electrical zero (N) ± 25 % deviation limit. Valid in vertical mounting position, measuring bolt lowered and in static measuring.

** For an amplitude of 10 % to the last value of the measuring range.

*** Distance from electrical zero.



DIN 32876 Part 1



See table



Nickel-plated housing, Stainless steel measuring bolt, hardened. Viton sealing bellows = highly resistant fluor elastomer



Fixing shank Ø 8 mm. Measuring bolt guided on ball-bearing. Distance from electrical zero of both stops is either adjustable (downward) or depending on the position of the lower stop (upward). Interchangeable inserts. M2,5 thread. Carbide ball tip Ø 3 mm. 2 m long cable, 5-pin DIN 45322 connector.



Supply frequency: 13 kHz (± 5 %) Max. mechanical frequency** 60 Hz.



0,2 µm/°C



20 ± 0,5°C



-10°C to 65°C



80 %



Protection level IP65 (IEC 60529)



Mobile weight: 6 g



Transport packaging



Identification number



Inspection report with a declaration of conformity



Standard Probes, ± 2 mm, 10,3 mm Travel, with Long Retraction Travel

Universal inductive probes for various applications, especially for use with multi-gauging inspection fixtures.

- Long retraction travel to prevent the probe from being damaged.
- Protection level IP65 as per IEC 60529.
- Large choice of accessories: measuring inserts, spring sets, etc.
- LVDT probes compatible with measuring equipment from other suppliers also available on request.



DIN 32876 Part 1



See table



Nickel-plated housing. Stainless steel measuring bolt, hardened. Viton bellows = high-resistance fluor elastomer



Fixing shank Ø 8 mm. Measuring bolt guided on ball-bearing. Distance from electrical zero of both stops is either adjustable (downward) or depending on the position of the lower stop (upward). Interchangeable inserts. M2,5 thread. Carbide ball tip Ø 3 mm. 2 m long cable. 5-pin DIN 45322 connector.



Supply frequency: 13 kHz (± 5 %) Max. mechanical frequency** 60 Hz.



0,15 µm/°C



20 ± 0,5°C



-10°C to 65°C



80 %



Protection level IP65 (IEC 60529)



Mobile weight: 8 g



Transport packaging



Identification number



Inspection report with a declaration of conformity



GT 27



GT 271



GT 28

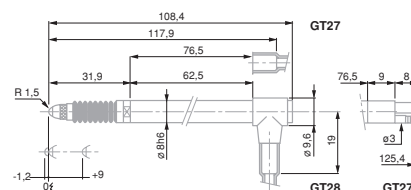

GT 27/ 28
GT 271

			Measuring range, mm	Nominal measuring force*, N	Measuring bolt retraction	Sealing bellows
03230027	GT 27	± 2	0,63	Mechanical	Viton	
03230073	GT 271	± 2	0,63	Mechanical / vacuum	Viton	
03230026	GT 28	± 2	0,63	Mechanical / vacuum	Viton	

	Measuring bolt travel, mm	Max. permissible error for deviations in linearity, µm (L in mm)	Repeatability, µm	Hysteresis, µm	Setting of measuring bolt lower stop***, mm (factory setting)	Cable output	Data Sheet No.	
GT 27	10,3	0,2 + 3 · L ³	0,05	0,05	-2,2 to 0,1 (factory setting -1,2)	Axial	03200251	
GT 271	10,3	0,2 + 3 · L ³	0,05	0,05	-2,2 to 0,1 (factory setting -1,2)	Axial	03200436	
GT 28	10,3	0,2 + 3 · L ³	0,05	0,05	-2,2 to 0,1 (factory setting -1,2)	Radial	03200252	

* Electrical zero (N) ± 25 % deviation limit. Valid in vertical mounting position, measuring bolt lowered and in static measuring.

** For an amplitude of 10 % to the last value of the measuring range.

*** Distance from electrical zero



Standard Probes ± 5 mm, 10,3 mm Bolt Travel, Extended Range

- Designed for long measuring travels and low resolution of values
- Specially suited for use on multigauging inspection fixtures.
- Correction factor applied to get the true value is 2,5x (10x for the S probe version).
- Protection level IP 65 as per IEC 60529.
- Large choice of accessories: Measuring inserts, spring sets, etc.
- LVDT probes compatible with measuring equipment from other suppliers also available on request.



GT 61



GT 62

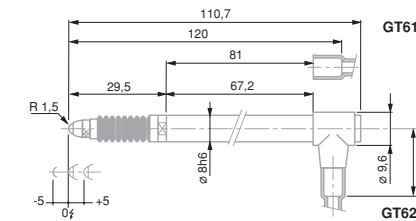

GT 61 / GT 62

		Measuring range, mm	Nominal measuring force*, N	Measuring bolt retraction	Sealing bellows	
03230041	GT 61	± 5	0,90	Mechanical	Viton	
03230042	GT 62	± 5	0,90	Mechanical / vacuum	Viton	

	Measuring bolt travel, mm	Max. permissible error for deviations in linearity, µm (L in mm)	Repeatability, µm	Hysteresis, µm	Measuring bolt***, mm (factory setting)	Cable output	Data Sheet No.	
GT 61	10,3	1 + 4 · L (BPX: 0,2 + 0,8 · L)	0,05	0,05	Lower - 5,1 upper + 5,2 (factory setting -5)	Axial	03200294	
GT 62	10,3	1 + 4 · L (BPX: 0,2 + 0,8 · L)	0,05	0,05	Lower - 5,1 upper + 5,2 (factory setting -5)	Radial	03200295	

* Electrical zero (N) ± 25 % deviation limit. Valid in vertical mounting position, measuring bolt lowered and in static measuring.
 ** For an amplitude of 10 % to the last value of the measuring range.
 *** Distance from electrical zero.

- DIN 32876 Part 1
- See table
- Nickel-plated housing, Stainless steel measuring bolt, hardened. Viton bellows = highly resistant fluoroe-lastomer
- Fixing shank Ø 8 mm. Measuring bolt guided on ball-bearing. Distance from electrical zero of both stops is either adjustable (downward) or depending on the position of the lower stop (upward). Interchangeable inserts. M2,5 thread. Carbide ball tip Ø 3 mm. 2 m long cable, 5-pin DIN 45322 connector.
- Supply frequency: 13 kHz (± 5 %) Max. mechanical frequency** 60 Hz.
- 0,09 µm/°C
- 20 ± 0,5°C
- 10°C to 65°C
- 80 %
- Protection level IP65 (IEC 60529)
- Mobile weight: 8 g
- Transport packaging
- Identification number
- Inspection report with a declaration of conformity



GT 21 HP High Precision Probes, ± 0,2 mm, 4,3 mm Travel

- Universal probe for common and continuous use applications.
- Very high precision probe suited for the measurement of gauge blocks.
- 8 mm diameter probe housing. Can be clamped over its entire length.
- Measuring bolt mounted on a ball bearing.
- Both the probe housing and ball-bearing guide are separate from one another, so that the measuring bolt moves easily even if the probe is not clamped appropriately.
- Level of protection IP65 according to IEC 60529.
- Wide range of accessories including measuring inserts, spring sets, etc.
- LVDT probes compatible with measuring equipment from other makers available on request.



GT 21 HP

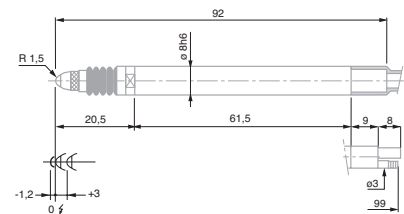

GT 21 HP

- DIN 32876 Part 1
- See table
- Nickel-plated housing. Stainless steel measuring bolt, hardened. Nitrile sealing bellow = resistant elastomer
- Fixing shank Ø 8 mm. Measuring bolt guided on ball-bearing. Distance from electrical zero of both stops is either adjustable (downward) or depending on the position of the lower stop (upward). Interchangeable inserts. M2,5 thread. Carbide ball tip Ø 3 mm. 2 m long cable. 5-pin DIN 45322 connector.
- Supply frequency: 13 kHz (± 5 %) Max. mechanical frequency** 60 Hz.
- 0,15 µm/°C
- 20 ± 0,5°C
- 10°C to 40°C
- 80 %
- Protection level IP65 (IEC 60529)
- Mobile weight: 6 g
- Transport packaging
- Identification number
- Inspection report with a declaration of conformity

03230036	GT 21 HP	Measuring range, mm	Measuring force, nominal*, N	Bolt retraction	Sealing bellows
		± 0,2	0,63	Mechanical	Nitrile

GT 21 HP	Measuring bolt travel, mm	Max. permissible error for deviations in linearity, µm (L in mm)	Repeatability, µm	Hysteresis, µm	Setting of lower stop of measuring bolt***, mm (factory setting)	Cable output	Data Sheet No.
	4,3	07 + 0,4 · L	0,01	0,01	-2,2 to +0,1 (factory setting -1,2)	Axial	03200264

* Electrical zero (N) ± 25 % deviation limit. Valid in vertical mounting position, measuring bolt lowered and in static measuring.
 ** For an amplitude of 10 % to the last value of the measuring range.
 *** Distance from electrical zero.



GT 22 HP High Precision Probe, ± 0,2 mm, 4,3 mm Travel

Universal probe for standard and continuous use applications.

- Very high precision probe suitable for the measurement of gauge blocks.
- 8 mm diameter probe housing. Can be clamped over its entire length.
- Measuring bolt mounted on a ball bearing.
- Both the probe housing and ball-bearing guide are separate from one another, so that the measuring bolt moves easily even if the probe is not clamped appropriately.
- Level of protection IP65 according to IEC 60529.
- Wide range of accessories including measuring inserts, spring sets, etc.
- LVDT probes compatible with measuring equipment from other makers available on request.



GT 22 HP

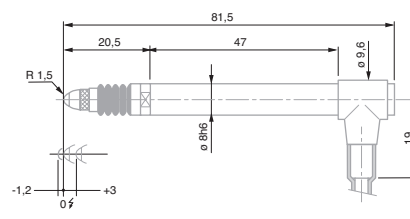

GT 22 HP

No	Measuring range, mm	Measuring force, nominal*, N	Bolt retraction	Sealing bellows
03230021	GT 22 HP ± 0,2	0,63	Mechanical or vacuum	Nitrile

	Measuring travel, mm	Max. permissible error for deviations in linearity, µm (L in mm)	Repeatability, µm	Hysteresis, µm	Setting of lower stop of the measuring bolt***, mm (factory setting)	Cable output	Data Sheet No.
GT 22 HP	4,3	0,07 + 0,4 · L	0,01	0,01	-2,2 to +0,1 (usine -1,2)	Radial	03200265

* Electrical zero (N) ± 25 % deviation limit. Valid in vertical mounting position, measuring bolt lowered and in static measuring.

** For an amplitude of 10 % to the last value of the measuring range.

*** Distance from electrical zero.



DIN 32876 Part 1



See table



Nickel-plated housing. Stainless steel measuring bolt, hardened. Nitrile sealing bellows = resistant elastomer



Fixing shank Ø 8 mm. Measuring bolt guided on ball-bearing. Distance from electrical zero of both stops is either adjustable (downward) or depending on the position of the lower stop (upward). Interchangeable inserts. M2,5 thread. Carbide ball tip Ø 3 mm. 2 m long cable. 5-pin DIN 45322 connector.



Supply frequency: 13 kHz (± 5 %) Max. mechanical frequency*** 60 Hz.



0,15 µm/°C



20 ± 0,5°C



10°C to 40°C



80 %



Protection level IP65 (IEC 60529)



Mobile weight: 6 g



Transport packaging



Identification number



Inspection report with a declaration of conformity



Pneumatic Probes ± 1,5 mm, 3,2 mm Bolt Travel, Linear

Probes for use with measuring fixtures or inspection machines integrating semi-automated or automated measuring routines.

- 8 mm diameter probe housing. Can be clamped over its entire length.
- Measuring bolt mounted on a ball bearing.
- Both the probe housing and ball-bearing guide are separate from one another, so that the measuring bolt moves easily even if the probe is not clamped appropriately.
- Degree of protection IP65 according to IEC 60529.
- Wide range of accessories including measuring inserts, etc.
- LVDT probes compatible with measuring equipment from other makers available on request.

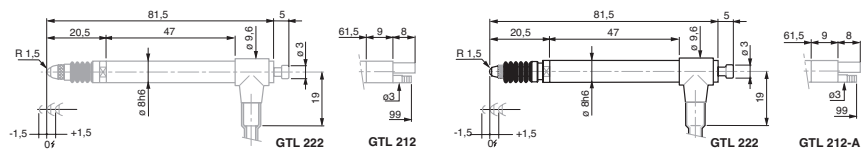

GTL 222



GTL 212



GTL 212-A



GTL 222-A



DIN 32876 Part 1



See table



Nickel-plated housing. Stainless steel measuring bolt, hardened. Viton sealing bellow = highly resistant fluoroelelastomer



Fixing shank Ø 8 mm. Measuring bolt guided on ball-bearing. Distance from electrical zero of both stops is either adjustable (downward) or depending on the position of the lower stop (upward). Interchangeable inserts. M2,5 thread. Carbide ball tip Ø 3 mm. 2 m long cable. 5-pin DIN 45322 connector.



Supply frequency: 13 kHz (± 5 %) Max. mechanical frequency** 60 Hz.



0,2 µm/°C



20 ± 0,5°C



-10°C to 65°C



80 %



Protection level: IP65 (IEC 60529) or IP50 for GTL 212-A and GTL 222-A



Mobile weight: 6 g



Transport packaging



Identification number



Inspection report with a declaration of conformity

No	=	Table	Hand	Star	Star	Star
		Measuring range, mm	Measuring force, nominal*, N	Measuring bolt retraction	Sealing bellows	Nominal/Maximal pressure, bar
03230060	GTL 212	± 1,5	1,2	Pressure (bolt activation), spring (bolt retraction)	Viton	0,7 / max 1,0
03230054	GTL 222	± 1,5	1,2	Pressure (bolt activation), spring (bolt retraction)	Viton	0,7 / max 1,0
03230067	GTL 212-A	± 1,5	0,2	Pressure (bolt activation), spring (bolt retraction)	Without bellows	0,25 / max 6,0
03230063	GT 222-A	± 1,5	0,2	Pressure (bolt activation), spring (bolt retraction)	Without bellows	0,25 / max 6,0

=	Table	Star	Star	Star	Star	Warning
Measuring bolt travel, mm	Max. permissible error for deviations in linearity, µm (L in mm)	Repeatability, µm	Hysteresis, µm	Cable output	Data Sheet No.	
GTL 212	3,2	0,2 + 2,4 · L ² (BPX: 0,2 + 0,8 · L)	0,015	0,02	Axial	03200413
GTL 222	3,2	0,2 + 2,4 · L ² (BPX: 0,2 + 0,8 · L)	0,015	0,02	Radial	03200393
GTL 212-A	3,2	0,2 + 2,4 · L ² (BPX: 0,2 + 0,8 · L)	0,015	0,02	Axial	03200430
GT 222-A	3,2	0,2 + 2,4 · L ² (BPX: 0,2 + 0,8 · L)	0,015	0,02	Radial	03200422

* Electrical zero (N) ± 25 % deviation limit. Valid in vertical mounting position, measuring bolt lowered and in static measuring.

** For an amplitude of 10 % to the last value of the measuring range.



Pneumatic Probes ± 2 mm, 10,3 mm Bolt Travel, with Long Retraction Travel

These probes are intended for use with measuring fixtures or machines integrating automated and semi-automated measuring routines.

- 8 mm diameter probe housing. Can be clamped over its entire length.
- Measuring bolt mounted on a ball bearing.
- Both the probe housing and ball-bearing guide are separate from one another, so that the measuring bolt moves easily even if the probe is not clamped appropriately.
- Degree of protection IP65 according to IEC 60529.
- Wide range of accessories including measuring inserts, etc.
- LVDT probes compatible with measuring equipment from other makers available on request.

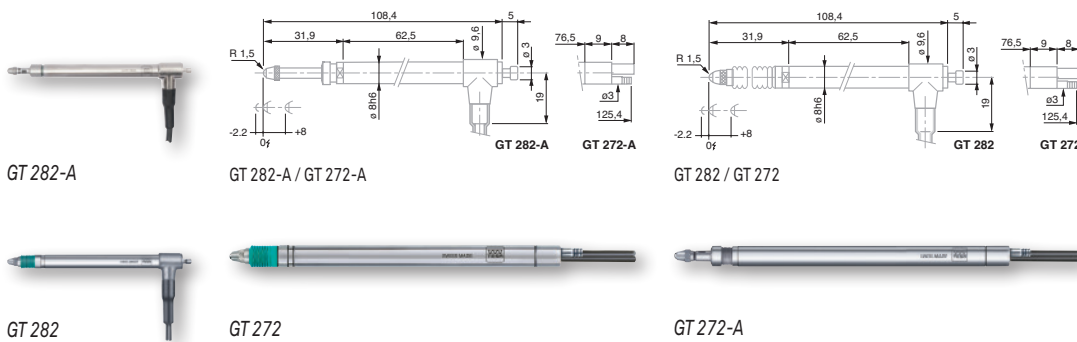

GT 282-A

GT 282-A / GT 272-A

GT 282 / GT 272

GT 282

GT 272

GT 272-A

No	=	Measuring range, mm	Measuring force, nominal*, N	Bolt retraction	Sealing bellows	Nominal/Maximal pressure, bar
03230061	GT 272	± 2	1,0	Pressure (bolt activation), spring (bolt retraction)	Viton	1,1 / max 1,5
03230053	GT 282	± 2	1,0	Pressure (bolt activation), spring (bolt retraction)	Viton	1,1 / max 1,5
03230068	GT 272-A	± 2	0,85	Pressure (bolt activation), spring (bolt retraction)	Without bellows	1,0 / max 6,0
03230069	GT 282-A	± 2	0,85	Pressure (bolt activation), spring (bolt retraction)	Without bellows	1,0 / max 6,0

=	Measuring bolt travel, mm	Max. permissible error for deviations in linearity, µm (L in mm)	Repeatability, µm	Hysteresis, µm	Cable output	Data Sheet No.
GT 272	10,3	0,2 + 3 · L ³	0,05	0,05	Axial	03200414
GT 282	10,3	0,2 + 3 · L ³	0,05	0,05	Radial	03200390
GT 272-A	10,3	0,2 + 3 · L ³	0,05	0,05	Axial	03200431
GT 282-A	10,3	0,2 + 3 · L ³	0,05	0,05	Radial	03200432

* Electrical zero (N) ± 25 % deviation limit. Valid in vertical mounting position, measuring bolt lowered and in static measuring.

** For an amplitude of 10 % to the last value of the measuring range.



DIN 32876 Part 1



See table



Nickel-plated housing. Stainless steel measuring bolt, hardened. Viton sealing bellows = highly resistant fluoroelelastomer



Fixing shank Ø 8 mm. Measuring bolt guided on ball-bearing. Distance from electrical zero of both stops is either adjustable (downward) or depending on the position of the lower stop (upward). Interchangeable inserts. M2,5 thread. Carbide ball tip Ø 3 mm. 2 m long cable, 5-pin DIN 45322 connector.



Supply frequency: 13 kHz (± 5 %) Max. mechanical frequency** 60 Hz.



0,15 µm/°C



20 ± 0,5°C



-10°C to 65°C



80 %



Protection level: IP65 (IEC 60529), IP64 for GT 21 HP



Mobile weight: 8 g



Transport packaging



Identification number



Inspection report with a declaration of conformity



Pneumatic Probes ± 5 mm, 10,3 mm Bolt Travel, Long Travel

These probes are designed for use with measuring fixtures and machines with integrated automatic or semi-automatic measuring routines.

- Probes with long measuring travel and low resolution of values 8 mm dia. fixing shank.
- Suitable for multi-gauging inspection fixtures.
- Protection level IP65 ou IP50 as per IEC 60529.
- Wide range of accessories including measuring inserts, etc.
- LVDT probes compatible with measuring equipment from other suppliers available on request.



DIN 32876 Part 1

See table

Nickel-plated housing. Stainless steel measuring bolt, hardened. Viton sealing bellows = highly resistant fluoroelastomer

Fixing shank Ø 8 mm. Measuring bolt guided on ball-bearing. Distance from electrical zero of both stops is either adjustable (downward) or depending on the position of the lower stop (upward). Interchangeable inserts. M2,5 thread. Carbide ball tip Ø 3 mm. 2 m long cable. 5-pin DIN 45322 connector.

Supply frequency: 13 kHz (± 5 %) Max. mechanical frequency** 60 Hz.

0,09 µm/°C

20 ± 0,5°C

-10°C to 65°C

80 %

Protection level: IP65 (IEC 60529),

Mobile weight: 8 g

Transport packaging

Identification number

Inspection report with a declaration of conformity

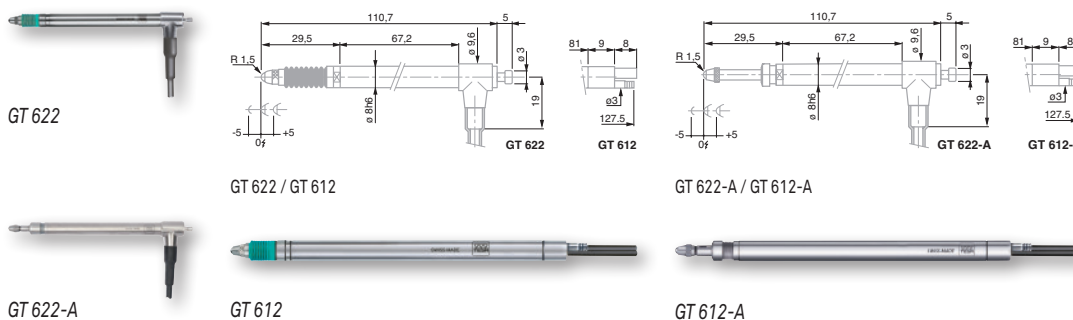

No	=	Measuring range, mm	Measuring force, nominal*, N	Bolt retraction	Sealing bellows	Nominal/Maximal pressure, bar
03230062	GT 612	± 5	2,0	Pressure (bolt activation), spring (bolt retraction)	Viton	1,1 / max 1,5
03230055	GT 622	± 5	2,0	Pressure (bolt activation), spring (bolt retraction)	Viton	1,1 / max 1,5
03230070	GT 612-A	± 5	1,0	Pressure (bolt activation), spring (bolt retraction)	Without bellows	1,0 / max 6,0
03230071	GT 622-A	± 5	1,0	Pressure (bolt activation), spring (bolt retraction)	Without bellows	1,0 / max 6,0

=	Measuring bolt travel, mm	Max. permissible error for deviations in linearity, µm (L in mm)	Repeatability, µm	Hysteresis, µm	Cable output	Data sheet No.
GT 612	10,3	1 + 4 · L (BPX: 0,6 + 0,8 · L)	0,05	0,05	Axial	03200415
GT 622	10,3	1 + 4 · L (BPX: 0,6 + 0,8 · L)	0,05	0,05	Radial	03200394
GT 612-A	10,3	1 + 4 · L (BPX: 0,6 + 0,8 · L)	0,05	0,05	Axial	03200433
GT 622-A	10,3	1 + 4 · L (BPX: 0,6 + 0,8 · L)	0,05	0,05	Radial	03200434

* Electrical zero (N) ± 25 % deviation limit. Valid in vertical mounting position, measuring bolt lowered and in static measuring.
 ** For an amplitude of 10 % to the last value of the measuring range.



Wireless Probe ± 2 mm

Probes developed for devices requiring a greater freedom of movement during the measurement or for parts with large dimensions.

Bidirectional and wireless communication synchronized with the TWIN-STATION Receiver.

- Resolution 0,1 μ m.
- Range of 8 m, depending on environment.
- TESA wireless communication protocol independent of WiFi or Bluetooth.
- Autonomy 40 hours (rechargeable battery).
- Mounting stem \varnothing 8 mm with clamping possible over entire length.
- Measuring bolt mounted on ball bearing.
- Ball bearing guide separated from mounting stem in order not to negatively influence the movement of the measuring bolt in the event of improper clamping of the probe body.
- Level of protection IP54 according to IEC 60529.
- Wide range of measurement inserts.
- Swiss made.
- The TWIN-STATION (part number 05030012) manages and synchronizes up to 8 wireless probes.
- Interface Software TIS included in delivery content of the TWIN-STATION (part number 05030012): display of measured values, possibility to indicate tolerances, simple functions +A, -A, +A+B, +A-B, and export of values as a .csv file.

Note: The sale is limited to EU countries, Switzerland, USA, Canada and China.



GTL 21 W

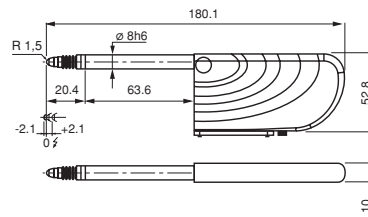

GTL 21 W

		Measuring range, mm	Nominal measuring force*, N	Bolt retraction	Sealing bellows
03230500	GTL 21 W	± 2	0,63	Mechanical	Viton
OPTIONAL ACCESSORY:					
05030012	TWIN Station Interface for wireless probes				

	Max. plunger travel, mm	Maximum permissible error, μ m (L in mm)	Repeatability, μ m	Hysteresis, μ m	Setting of lower stop of the measuring bolt***, mm	Cable output	Data sheet No.
GTL 21 W	4,3	0,4 + 0,8 · L	0,10	0,5	Fixed stops: lower -2,1 upper +2,1	Without cable	03200602

* Electrical zero (N) ± 25 % deviation limit. Valid in vertical mounting position, measuring bolt lowered and in static measuring.
 ** For an amplitude of 10 % to the last value of the measuring range.
 *** Distance from electrical zero.

- DIN 32876 Part 1
- See table
- Nickel-plated housing
Stainless steel measuring bolt, hardened
Viton sealing bellows = highly resistant fluoroe-lastomer
- Fixing body nickel \varnothing 8 mm
Stainless steel measuring bolt, hardened and ball bearing guided
Fixed upper and lower stops
Interchangeable inserts
M2,5 thread
Carbide ball \varnothing 3 mm
Mini jack connector for charger.
- Mechanical max. frequency**: 60 Hz
Power supply: 100 \div 240 VAC, 50 \div 60 Hz; 240 mAh
Rechargeable battery: 3,7 V, min. 550 mAh or 800 mAh
Frequency band: 2,4 GHz
Range: 8 m, depending on environment.
- $\pm 0,2$ μ m/ $^{\circ}$ C
- $20 \pm 0,5$ $^{\circ}$ C
- 10° C to 40° C
- 80 %
- Protection level IP54 (IEC 60529)
- GTL 21 W: 6g
- Transport packaging
- Identification number
- Inspection report with a declaration of conformity



Wireless Probe ± 5 mm, Large Measuring Range

Probes developed for devices requiring a greater freedom of movement during the measurement or for parts with large dimensions.

Bidirectional and wireless communication synchronized with the TWIN-STATION Receiver.

- Resolution 0,1 µm.
- Range of 8 m, depending on environment.
- TESA wireless communication protocol independent from WiFi or Bluetooth.
- Autonomy 40 hours (rechargeable battery).
- Mounting body Ø 8 mm with possibility of clamping over entire length.
- Measuring bolt mounted on ball bearing.
- Separate guide bearing on the mounting body in order not to negatively influence the movement of the measuring bolt in the event of improper clamping on the probe body.
- Level of protection IP54 according to IEC 60529.
- Wide range of measurement probes.
- Swiss made.
- The TWIN-STATION (part number 05030012) manages and synchronizes up to 8 wireless probes.
- Interface Software TIS included in supply content of the TWIN-STATION (part number 05030012): display of measured values, possibility to indicate tolerances, simple functions +A, -A, +A+B, +A-B, and export of values in a .csv file.

Note: The sale is limited to EU countries, Switzerland, USA, Canada and China.



DIN 32876 Part 1

See table

Nickel-plated housing
Stainless steel measuring bolt, hardened. Viton = highly resistant fluoroelelastomer

Fixing shank Ø 8 mm. Measuring bolt guided on ball-bearing. Distance from electrical zero of both stops is either adjustable (downward) or depending on the position of the lower stop (upward). Interchangeable inserts. M2,5 thread. Carbide ball tip Ø 3 mm. Connector Mini-jack for charger.

Mechanical max. frequency**: 60 Hz
Power supply: 100 ÷ 240 VAC, 50 ÷ 60 Hz; 240 mAh
Rechargeable battery: 3,7 V, min. 550 mAh or 800 mAh
Frequency band: 2,4 GHz
Range: 8 m, depending on environment.

± 0,2 µm/°C

20 ± 0,5°C

10°C to 40°C

80 %

Protection operating envelope IP54 (IEC 60529)

GT 61 W: 8 g

Transport packaging

Identification number

Inspection report with a declaration of conformity



GT 61 W

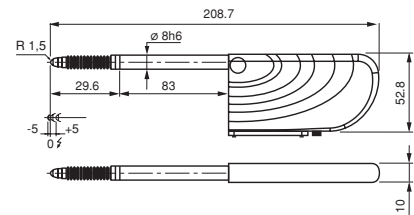

GT 61 W

No	=	Measuring range, mm	Nominal measuring force*, N	Bolt retraction	Sealing bellows
03230502	GT 61 W	± 5	0,9	Mechanical	Viton
OPTIONAL ACCESSORY:					
05030012	TWIN Station Interface for wireless probes				

	Max. bolt travel, mm	Maximum permissible error, µm (L in mm)	Repeatability, µm	Hysteresis, µm	Setting of lower stop of measuring bolt***, mm	Cable output	Data sheet No.
GT 61 W	10,3	0,8 + 0,8- L	0,24	0,5	Fixed stops lower -5 upper +5	Without cable	03200621

* Electrical zero (N) ± 25 % deviation limit. Valid in vertical mounting position, measuring bolt lowered and in static measuring.

** For an amplitude of 10 % to the last value of the measuring range.

*** Distance from electrical zero.



Wireless Pneumatic Probe $\pm 1,5$ mm

Probes developed for devices requiring a greater freedom of movement during the measurement or for parts with large dimensions.

Bidirectional and wireless communication synchronized with the TWIN-STATION Receiver.

- Resolution 0,1 μ m.
- Range of 8 m, depending on environment.
- TESA wireless communication protocol independent from WiFi or Bluetooth
- Autonomy 40 hours (rechargeable battery).
- Support structure \varnothing 8 mm with enhanced clamping over its entire length
- Measuring rod mounted on ball bearing.
- Separate guide bearing on the holding body in order not to negatively influence the movement of the measuring rod in the event of improper clamping of the probe beads.
- Level of protection IP54 according to IEC 60529.
- Wide range of measurement probes.
- Swiss made.
- The TWIN-STATION (part number 05030012) manages and synchronizes up to 8 wireless probes.
- Interface Software TIS included in delivery content of the TWIN-STATION (art. 05030012): display of measured values, possibility to indicate tolerances, simple functions +A, -A, +A+B, +A-B, and export of values in a .csv file.

Note: The sale is limited to EU countries, Switzerland, USA, Canada and China.



GTL 212 W

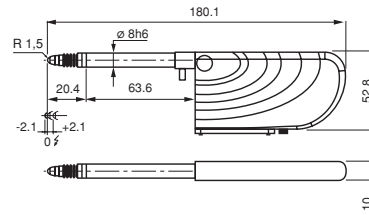

GTL 212 W

No	=	Measuring range, mm	Nominal measuring force*, N	Bolt retraction	Sealing bellows	Nominal/maximal pressure, bar
03230501	GTL 212	$\pm 1,5$	1,2	Pressure (bolt activation), spring (bolt retraction)	Viton	0,7 / max. 1,0

OPTIONAL ACCESSORY:

05030012 TWIN Station Interface for wireless probes

=	Max. measuring bolt travel, mm	Maximum permissible error, μ m (L in mm)	Repeatability, μ m	Hysteresis, μ m	Setting of lower stop of the measuring bolt***, mm	Cable output	Data sheet No.
GTL 212 W	4,3	0,4 + 0,8 · L	0,10	0,5	Fixed stops: lower -2,1 upper +2,1	Without cable	03200620

* Electrical zero (N) ± 25 % deviation limit. Valid in vertical mounting position, measuring bolt lowered and in static measuring.

** For an amplitude of 10 % to the last value of the measuring range.

*** Distance from electrical zero.

- DIN 32876 Part 1
- See table
- Nickel-plated housing
Stainless steel measuring bolt, hardened
Viton sealing bellows = highly resistance fluororelastomer
- Fixing body nickel \varnothing 8 mm
Stainless steel measuring bolt, hardened and ball bearing guided
Fixed upper and lower stops
Probe interchangeable
M2,5 thread
Carbide ball \varnothing 3 mm
Mini jack connector for charger.
- Mechanical max. frequency**: 60 Hz
Power supply: 100 \div 240 VAC, 50 \div 60 Hz; 240 mAh
Rechargeable battery: 3,7 V, min. 550 mAh or 800 mAh
Frequency band: 2,4 GHz
Range: 8 m, depending on environment.
- $\pm 0,2$ μ m/ $^{\circ}$ C
- $20 \pm 0,5$ $^{\circ}$ C
- 10° C to 40° C
- 80 %
- Protection IP54 (IEC 60529)
- GTL 212 W: 6g
- Transport packaging
- Identification number
- Inspection report with a declaration of conformity



Wireless Pneumatic Probe ± 5 mm, Large Measuring Range

Probes developed for devices requiring a greater freedom of movement during the measurement or for pieces with large dimensions.

Bidirectional and wireless communication synchronized with the TWIN-STATION Receiver.

- Resolution 0,1 µm.
- Range of 8 m, depending on environment.
- TESA wireless communication protocol independent from WiFi or Bluetooth.
- Autonomy 40 hours (rechargeable battery).
- Mounting body Ø 8 mm with enhanced clamping over its entire length.
- Measuring bolt mounted on ball bearing.
- Separate guide bearing on the holding body in order not to negatively influence the movement of the measuring bolt in the event of improper clamping on the probe body.
- Level of protection IP54 according to IEC 60529.
- Wide range of measurement probes.
- Swiss made.
- The TWIN-STATION (part number 05030012) manages and synchronizes up to 8 wireless probes.
- Interface Software TIS included in delivery content of the TWIN-STATION (art. 05030012): display of measured values, possibility to indicate tolerances, simple functions +A, -A, +A+B, +A-B, and export of values in a .csv file.

Note: The sale is limited to EU countries, Switzerland, USA, Canada and China.



GT 612 W

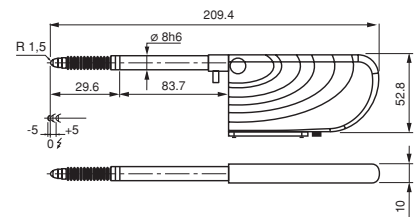

GT 612 W

- DIN 32876 Part 1
- See table
- Nickel-plated housing
Stainless steel measuring bolt, hardened
Viton sealing bellows = highly resistance fluoroe-lastomer
- Fixing body nickel Ø 8 mm
Stainless steel measuring bolt, hardened and ball bearing guided
Fixed upper and lower stops
Probe interchangeable
M2, 5 thread
Carbide ball Ø 3 mm
Mini jack connector for charger
- Mechanical max. frequency**: 60 Hz
Power supply: 100 ÷ 240 VAC, 50 ÷ 60 Hz; 240 mAh
Rechargeable battery: 3,7 V, min. 550 mAh or 800 mAh
Frequency band: 2,4 GHz
Range: 8 m, depending on environment.
- Wireless transmission, TWIN-STATION Receiver (05030012)
- ± 0,2 µm/°C
- 20 ± 0,5°C
- 10°C to 40°C
- 80 %
- Protection level IP54 (IEC 60529)
- GT 612 W: 8 g
- Transport packaging
- Identification number
- Inspection report with a declaration of conformity

No	GT 612 W	Measuring range, mm	Nominal measuring force*, N	Bolt retraction	Sealing bellows	Nominal/maximal pressure, bar
03230503	GT 612 W	± 5	2,0	Pressure (bolt activation), spring (bolt retraction)	Viton	1,1 / max. 1,5

OPTIONAL ACCESSORY:

05030012 TWIN Station Interface for wireless probes

Max. bolt travel, mm	Maximum permissible error, µm (L in mm)	Repeatability, µm	Hysteresis, µm	Setting of lower stop of measuring bolt***, mm	Cable output	Data sheet No.	
GT 612 W 10,3	0,8 + 0,8 · L	0,24	0,5	Fixed stops: lower -5 upper +5	Without cable	03200622	

* Electrical zero (N) ± 25 % deviation limit. Valid in vertical mounting position, measuring bolt lowered and in static measuring.

** For an amplitude of 10 % to the last value of the measuring range.

*** Distance from electrical zero.



USB Probes ± 2 mm, 4,3 mm Range

Universal probes for applications aided by a USB connection.

- Probe mounting body Ø 8 mm with enhanced clamping over its entire length.
- Measuring bolt mounted on ball bearing.
- Separate guide bearing on the mounting body in order not to negatively influence the movement of the measuring bolt in the event of improper clamping of the probe beads.
- Level of protection IP65 according to IEC 60529.
- Wide range of measurement inserts.
- TSIP software interface included in supply 1 to 4 USB probes display.
- Possibility of indicating tolerances and simple functions + A, -A, + A + B + AB.
- To manage more than 4 probes USB, use the DataDirect (part number 04981001) or StatExpress software (part number 04981002), available as an option.



TSIP Software

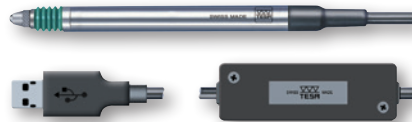

GTL 21 USB

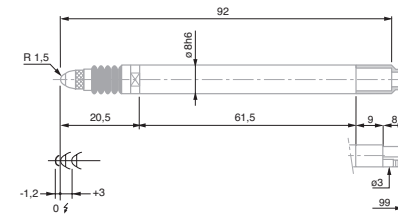

GTL 21 USB



GTL 22 USB

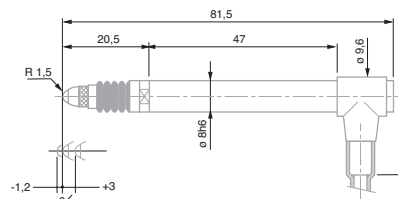

GTL 22 USB

		Measuring range, mm	Nominal measuring force*, N	Bolt retraction	Sealing bellows
03230200	GTL21 USB	± 2	0,63	Mechanical	Viton
03230201	GTL 22 USB	± 2	0,63	Mechanical/vacuum	Viton

	Measuring bolt travel, mm	Max. permissible error, µm (L in mm)	Repeatability, µm	Hysteresis, µm	Setting of lower stop of measuring bolt*** mm	Cable output	Data sheet No.
GTL21 USB	4,3	0,4 + 0,8 · L	0,1	0,5	Fixed stops: lower -2,0 upper +2,0	Axial	03200587
GTL 22 USB	4,3	0,4 + 0,8 · L	0,1	0,5	Fixed stops: lower -2,0 upper +2,0	Radial	03200588

* Electrical zero (N) ± 25 % deviation limit. Valid in vertical mounting position, measuring bolt lowered and in static measuring.

** For an amplitude of 10 % to the last value of the measuring range.

*** Distance from electrical zero.



DIN 32876 Part 1



See table



Nickel-plated housing, Stainless steel measuring bolt, hardened. Viton sealing bellows = highly resistant fluoroelelastomer



Fixing body Ø 8 mm. Measuring bolt guided on ball bearing. Fixed upper and lower stops. Interchangeable inserts. M 2,5 thread. Carbide ball Ø 3 mm. Cable length: 2,9 m. USB Type A plug connector



Max. mechanical frequency** 60 Hz.
Consumption: 70 mAh, 5V
Normal measuring interval = 80ms (optimal accuracy)
Minimal measuring interval = 20ms (most rapid transfer of data)
Stabilisation time after switching power on = 12 min.



0,2 µm/°C



20 ± 0,5°C



10°C to 40°C



80 %



IP65 (IEC 60529)



Mobile weight: 6 g



Transport packaging



Identification number



Inspection report with a declaration of conformity



USB Pneumatic Probes ± 1,5 mm, 3,1 mm Bolt Travel

Universal probes for applications facilitated by a USB connection

- Mounting body Ø 8 mm with possibility of clamping over its entire length.
- Measuring rod mounted on ball bearing.
- Separate guide bearing on the holding body in order not to negatively influence the movement of the measuring bolt in the event of improper clamping of the probe beads.
- Level of protection IP65 or IP50 according to IEC 60529.
- Wide range of measurement inserts.
- TSIP software interface included in supply: display 1 to 4 USB probes. Possibility of indicating tolerances and simple functions + A, -A, + A + B + AB.
- To manage more than 4 probes USB, use the DataDirect (part number 04981001) or StatExpress software (part number 04981002), available as an option.



DIN 32876 Part 1



See table



Nickel-plated housing. Stainless steel measuring bolt, hardened. Viton sealing bellows = highly resistant fluoroelelastomer



Fixing shank Ø 8 mm. Measuring bolt on ball bearing guide. Fixed lower and upper stops. Interchangeable measuring insert. Thread M2,5. Carbide ball Ø 3 mm Cable length: 2,9 m USB type A connector



Max. mechanical frequency** 60 Hz.
Consumption: 70 mAh, 5V
Normal measuring interval = 80ms (optimal accuracy)
Minimal measuring interval = 20ms (most rapid transfer of data)
Stabilisation time after switching power on = 12 min.
Remark: Compressed air supply must be generated through a filter and precision regulator. The air should have a humidity of < 60% and be filtered to < 0,5 µm.



0,2 µm/°C



20 ± 0,5°C



10°C to 40°C



80 %



IP65 (IEC 60529) or IP50 for GTL 222-A



Mobile weight: 6 g



Transport packaging



Identification number



Inspection report with a declaration of conformity



GTL 222 USB

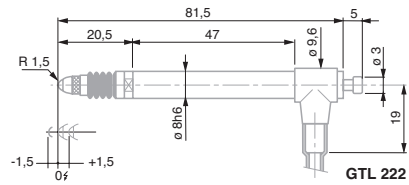

GTL 222 USB



TSIP Software

No	=	Table	Hand	Gear	Gear	Gear
03230202	GTL222 USB	Measuring range, mm	Nominal measuring force*, N	Bolt retraction	Sealing bellows	Nominal/Maximal Pressure, bar
		± 1,5	1,2	Pressure (bolt activation), spring (bolt retraction)	Viton	0,7 / max 1,0

=	Table	Hand	Hand	Hand	Gear	Warning
GTL222 USB	Measuring bolt travel, mm	Max. permissible error, µm (L in mm)	Repeatability, µm	Hysteresis, µm	Cable output	Data sheet No.
	3,1	0,4 + 0,8 · L	0,1	0,5	Radial	03200589

* Electrical zero (N) ± 25 % deviation limit. Valid in vertical mounting position, measuring bolt lowered and in static measuring.
** For an amplitude of 10 % to the last value of the measuring range.



USB Probes ± 5 mm, 10,3 mm Bolt Travel, Extended Measuring Range

USB universal probes for applications facilitated by a USB connection.

- Probes designed for long measuring travel and low resolution measurement values.
- Probe mounting body Ø 8 mm with possibility of clamping over its entire length.
- Measuring bolt mounted on ball bearing.
- Separate guide bearing on the holding body in order not to negatively influence the movement of the measuring bolt in the event of improper clamping of the probe beads.
- Level of protection IP65 according to IEC 60529.
- Wide range of measurement inserts.
- TSIP software interface included in supply 1 to 4 USB probes display. Possibility of indicating tolerances, simple functions + A, -A, + A + B + AB.
- To manage more than 4 USB probes, use the DataDirect (part number 04981001) or StatExpress software (part number 04981002), available as an option.



GT 61 USB

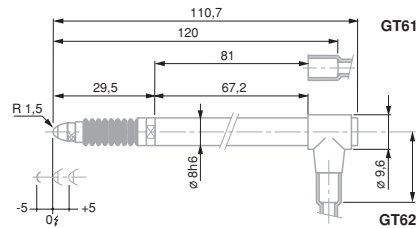

GT 61 USB / GT 62 USB



TSIP Software

No	=	Measuring range, mm	Nominal measuring force*, N	Bolt retraction	Sealing bellows
03230204	GT61 USB	± 5	0,90	Mechanical	Viton
03230205	GT62 USB	± 5	0,90	Mechanical/vacuum	Viton

=	Measuring bolt travel, mm	Max. permissible error, µm (L in mm)	Repeatability, µm	Hysteresis, µm	Settings of lower stop of bolt**, mm	Cable output	Data sheet No.
GT61 USB	10,3	0,8 + 0,8 · L	0,24	0,5	Fixed stops: lower -5,0 upper +5,0	Axial	03200591
GT62 USB	10,3	0,8 + 0,8 · L	0,24	0,5	Fixed stops: lower -5,0 upper +5,0	Radial	03200592

* Electrical zero (N) ± 25 % deviation limit. Valid in vertical mounting position, measuring bolt lowered and in static measuring.
 ** For an amplitude of 10 % to the last value of the measuring range.
 *** Distance from electrical zero.

- DIN 32876 Part 1
- See table
- Nickel-plated housing, Stainless steel measuring bolt, hardened. Viton sealing bellows = highly resistant fluor elastomer
- Fixing shank Ø 8 mm. Measuring bolt guided on ball-bearing. Distance from electrical zero of both stops is either adjustable (downward) or depending on the position of the lower stop (upward). Interchangeable inserts. M2,5 thread. Carbide ball tip Ø 3 mm. Cable length 2,9 m. USB type A connector. 5-pin DIN 45322 connector.
- Max. mechanical frequency 60 Hz
Power consumption: 70 mAh
Normal measurement interval = 80ms (maximum accuracy)
Minimum measurement interval = 20ms (fastest transfer data).
Stabilisation time after power on = 12 min
- 0,09 µm/°C
- 20 ± 0,5°C
- 10°C to +40°C
- 80 %
- IP65 (IEC 60529)
- Mobile weight: 8 g
- Transport packaging
- Identification number
- Inspection report with a declaration of conformity





DIN 32876 Part 1



See table



See standard probes technical data



Cable length: 2 m. DIN 45322 plug connector, 5 poles. Use to connect to a device with an analogue input. For more information, refer to technical data for standard probes



Supply voltage: ± 15 V
Consumption: 15 mA
Adjustable load: > 1 k Ω . Can be used in any position.
Special versions on request: Sensitivity: 2 V/mm, 5 V/mm, 10 V/mm output: 0 V to +10 V (max +10 V)



See standard probes technical data



See standard probes technical data



See standard probes technical data



80 %



See standard probes technical data



See standard probes technical data



Transport packaging



Identification number



See standard probes technical data

DC Probes ± 2 mm (Output Signal in V)

Probe provided with an electronic box which converts the signal to obtain an output DC voltage

Typically used for direct connection to a computer unit or interface equipped with an analogue input

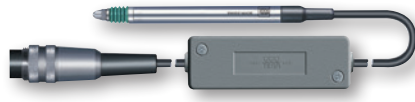

GTL 21 DC

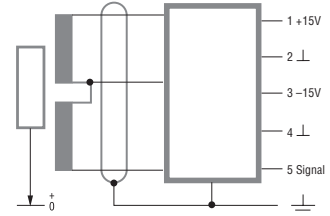

DIN 5 pin connection schematic

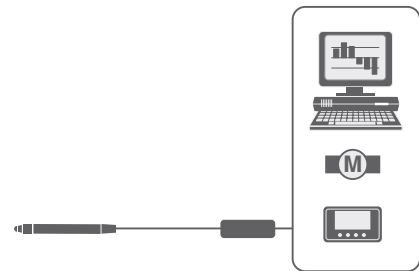

Connection of DC probe to a computer, an interface or a tracker

			Measuring range, mm	Nominal measuring force*, N	Bolt retraction	Sealing bellows	Output voltage, V	Sensitivity, V/mm
03230059	GTL 21 DC	± 2	0,63	Mechanical	Viton	± 2	1	
03230058	GTL 22 DC	± 2	0,63	Mechanical / vacuum	Viton	± 2	1	

		Measuring bolt travel, mm	Max. permissible error for deviations in linearity, μ m (L in mm)	Repeatability, μ m	Data sheet No.
GTL 21 DC	4,3	$0,2 + 3,5 \cdot L^2$	0,1	03200396	
GTL 22 DC	4,3	$0,2 + 3,5 \cdot L^2$	0,1	03200397	

* Electrical zero (N) ± 25 % deviation limit. Valid in vertical mounting position, measuring bolt lowered and in static measuring.



DC Probes ± 5 mm (Output Signal in V), with Extended Measuring Range

Probe provided with an electronic box which converts the signal to obtain an output DC voltage

Typically used for direct connection to a computer unit or an interface equipped with an analogue input

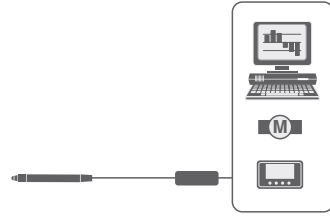

Connection of DC probe to a computer, an interface or a plotter

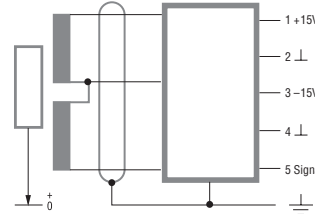

DIN 5 pin connector schematic

No	=	Measuring range, mm	Nominal measuring force*, N	Bolt retraction	Sealing bellows	Output voltage, V	Sensitivity, V/mm
03230086	GT 61 DC	± 5	0,9	Mechanical	Viton	± 5	1
03230087	GT 62 DC	± 5	0,9	Mechanical / vacuum	Viton	± 5	1

=	Measuring bolt travel, mm	Max. permissible error for deviations in linearity, μm (L in mm)	Repeatability, μm	Data sheet No.
GT 61 DC	10,3	$1 + 4 \cdot L$	0,1	03200519
GT 62 DC	10,3	$1 + 4 \cdot L$	0,1	03200520

* Electrical zero (N) ± 25 % deviation limit. Valid in vertical mounting position, measuring bolt lowered and in static measuring.



DIN 32876 Part 1



See table



See standard probes technical data



Cable length: 2 m. DIN 45322 plug connector, 5 poles. Use to connect to a device with an analogue input. For more information, refer to technical data on standard probes



Supply voltage: ± 15 V
Consumption: 15 mA
Adjustment load: $> 1 \text{ k}\Omega$
Can be used in any position. Special versions on request.
Sensitivity: 2 V/mm, 5 V/mm, 10 V/mm
Output: 0 V to +10 V (max +10 V).



See standard probes technical data



See standard probes technical data



See standard probes technical data



80 %



See standard probes technical data



See standard probes technical data



Transport packaging



Identification number



See standard probes technical data



DC Miniature Probes ± 1 mm (Output Signal in V)

Probe provided with an electronic box which converts the signal to obtain an output DC voltage

Typically used for direct connection to a computer unit or an interface equipped with an analogue input

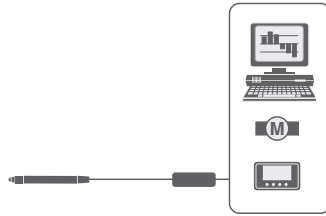

Connection of a DC probe to a computer, an interface or a plotter

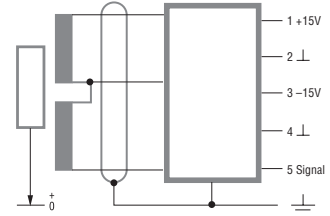

DIN 5 pin connection schematic



DIN 32876 Part 1



See table



See standard probes technical data



Cable length: 2 m. DIN 45322 plug connector, 5 poles. Use to connect to a device with an analog input. For more information, refer to technical data for standard probes



Drive voltage: ± 15 V
Consumption: 15 mA
Adjustment load: > 1 kΩ. Can be used in any position. Special versions on request. Sensitivity: 2 V/mm, 5 V/mm, 10 V/mm Output: 0 V à +10 V (max +10 V)



See standard probes technical data



See standard probes technical data



See standard probes technical data



80 %



See standard probes technical data



See standard probes technical data



Transport packaging



Identification number



See standard probes technical data

03230085	GT 44 DC	± 1	0,4	Mechanical / vacuum	Viton	± 1	1

GT 44 DC	2,1	0,2 + 5 · L ³	0,1	03200518

* Electrical zero (N) ± 25 % deviation limit. Valid in vertical mounting position, measuring bolt lowered and in static measuring.



Lever DC Probes ± 0,3 mm (Output Signal in V)

Probe provided with an electronic box which converts the signal to obtain an output DC voltage

Typically used for direct connection to a computer unit or an interface equipped with an analogue input

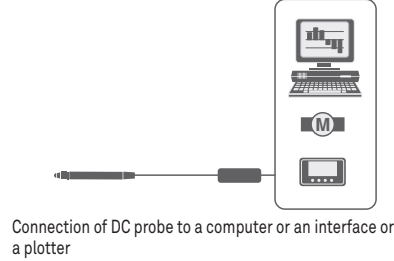
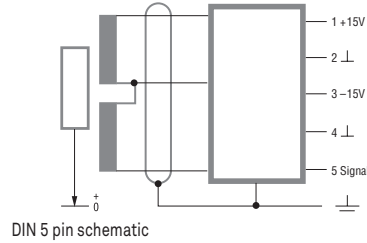

03230081	GT31 DC	± 0,3	0,1	Without retraction	Without bellows	± 0,3	1

GT31 DC	0,7	0,2 + 50 · L ²	0,1	03200484	

* Electrical zero (N) ± 25 % deviation limit. Valid in vertical mounting position, measuring bolt lowered and in static measuring.



DIN 32876 Part 1



See table



See standard probes technical data



Cable length: 2 m. DIN 45322 plug connector, 5 poles. Use to connect to a device with an analog input. For more information, refer technical data on standard probes



Drive voltage: ± 15 V
Consumption: 15 mA
Adjustment load: > 1 kΩ. Can be used in any measuring position. Special versions on request.
Sensitivity: 2 V/mm, 5 V/mm, 10 V/mm
Output: 0 V to +10 V (max +10 V)



See standard probes technical data



See standard probes technical data



See standard probes technical data



80 %



See standard probes technical data



See standard probes technical data



Transport packaging



Identification number



See standard probes technical data



GT 41 / GT 42 Miniature Probes, ± 0,3 mm, 0,7 mm Bolt Travel

Compact probes for use in small spaces – Designed to be mounted on a measuring head for the inspection of bores and similar features.



DIN 32876 Part 1

See table

Nickel-plated housing. Stainless steel measuring bolt, hardened. Sealing bellows: Nitrile = resistant elastomer. Viton = highly resistant fluoroelastomer.

Fixing shank Ø 8 mm. Ball-bearing measuring bolt. Both lower and upper stops are fixed. Interchangeable insert. M2,5 thread. Carbide ball tip Ø 3 mm. 2 m long cable. 5-pin DIN 45322 connector.

Supply frequency: 13 kHz (± 5 %) Max. mechanical frequency** 60 Hz.

0,1 µm/°C

20 ± 0,5°C

-10°C to 65°C

80 %

Level of protection: IP65 (IEC 60529)

Mobile weight: 2 g

Transport packaging

Identification number

Inspection report with a declaration of conformity



GT 41

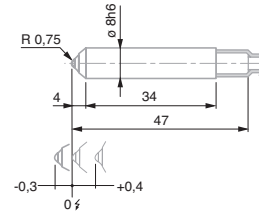

GT 41



GT 42

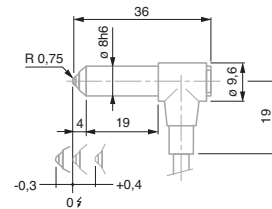

GT 42

No	=	Measuring range, mm	Nominal measuring force*, N	Bolt retraction	Sealing bellows
03230001	GT 41	± 0,3	0,63	None	Nitrile
03230002	GT 42	± 0,3	0,63	Vacuum	Nitrile

	=	Measuring bolt travel, mm	Max. permissible error for deviations in linearity, µm (L en mm)	Repeatability, µm	Hysteresis, µm	Setting of lower stop of measuring bolt***, mm	Cable output	Data sheet No.
GT 41	0,7	0,2 + 5 · L ²	0,01	0,01	Fixed stops: lower -0,3 upper +0,4	Axial	03200258	
GT 42	0,7	0,2 + 5 · L ²	0,01	0,01	Fixed stops: lower -0,3 upper +0,4	Radial	03200259	

* Electrical zero (N) ± 25 % deviation limit. Valid in vertical mounting position, measuring bolt lowered and in static measuring.

** For an amplitude of 10 % to the last value of the measuring range.

*** Distance from electrical zero.



GT 43 / GT 44 Miniature Probes, ± 1,0 mm , 2,1 mm Bolt Travel

Compact probes for use in small spaces – Designed to be mounted on a measuring head for the inspection of bores and similar features.



GT 43

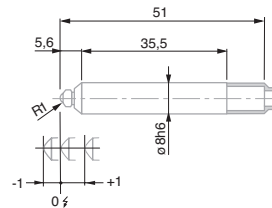

GT 43



GT 44

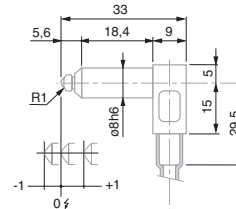

GT 44

			Measuring range, mm	Nominal measuring force*, N	Bolt retraction	Sealing bellows
03230035	GT 43	± 1	0,4	Mechanical	Viton	
03230017	GT44	± 1	0,4	Vacuum	Viton	

	Measuring bolt travel, mm	Max. permissible error for deviations in linearity, µm (L en mm)	Repeatability, µm	Hysteresis, µm	Setting of lower stop of bolt***, mm	Cable output	Data sheet No.	
GT 43	2,1	0,2 + 5 · L ²	0,1	0,15	Fixed stops: lower -1,05 upper +1,05	Axial	03200260	
GT44	2,1	0,2 + 5 · L ²	0,1	0,15	Fixed stops: lower -1,05 upper +1,05	Radial	03200261	

* Electrical zero (N) ± 25 % deviation limit. Valid in vertical mounting position, measuring bolt lowered and in static measuring.

** For an amplitude of 10 % to the last value of the measuring range.

*** Distance from electrical zero.



DIN 32876 Part 1



See table



Nickel-plated housing, Stainless steel measuring bolt, hardened. Sealing bellows: Nitrile = resistant elastomer. Viton = highly resistant fluoroelastomer.



Fixing shank Ø 8 mm. Ball-bearing measuring bolt. Both lower and upper stops are fixed. Interchangeable insert. Carbide ball tip Ø 3 mm. 2 m long cable. 5-pin DIN 45322 connector.



Supply frequency: 13 kHz (± 5 %) Max. mechanical frequency**: 60 Hz.



0,1 µm/°C



20 ± 0,5°C



-10°C to 65°C



80 %



Level of protection: IP65 (IEC 60529)



Mobile weight: 2 g



Transport packaging



Identification number



Inspection report with a declaration of conformity



Probes, Unbranded Execution, Series 410 ± 1 mm, 2,5 mm Range, Short Body

Universal probes for common but constraining applications.

- 8 mm diameter probe body that can be clamped over its entire length.
- Ball bearing measuring bolt.
- Hardened steel body, hard-chrome plated.
- Degree of protection to IP62.
- Flexible axial cable exit fitted with a steel spring to prevent the cable from breaking.
- Other probes compatible with measuring equipment from other makers also available on request.

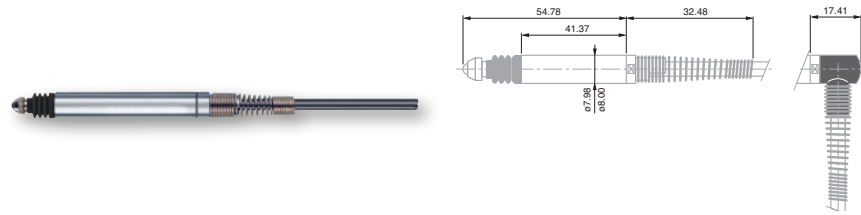

410

410 and accessory with radial cable exit (delivered with probe)

- DIN 32876 Part 1
- See in the table
- Nickel-plated housing. Stainless steel measuring bolt, hardened. Sealing bellows: Nitrile = resistant elastomer
- Fixing shank Ø 8 mm. Ball-bearing measuring bolt. Distance from electrical zero of both stops is either adjustable (downward) or depending on the position of the lower stop (upward). Interchangeable measuring insert with a 3 mm dia. tungsten carbide ball tip plus M2,5 thread. 2 m long cable. DIN 45322 5-pin connector.
- Supply frequency: 13 kHz (± 5 %) Max. mechanical frequency*: 60 Hz.
- 0,025 µm/°C
- 20 ± 0,5°C
- 10°C to +60°C
- IP65 (IEC 60529)
- Mobile weight: 3,1 g
- Shipping packaging
- Identification number

No	=				
96410012	410	Measuring range, mm	Nominal measuring force*, N	Bolt retraction	Sealing bellows
		± 1	0,60	Mechanical	Nitrile

Measuring bolt travel, mm	Max. permissible error for deviations in linearity, µm (L en mm)	Repeatability, µm	Setting of lower stop of the measuring bolt***, mm (factory setting)	Cable output	Data sheet No.
410	2,5	0,2 % (for a measuring span of ± 1 mm)	0,1	Adjustable from -1,2 to 0 (factory setting -1,08)	Axial and radial F96410012

* Electrical zero (N) ± 25 % deviation limit. Valid in vertical mounting position, measuring bolt lowered and in static measuring.

** For an amplitude of 10 % to the last value of the measuring range.

*** Distance from electrical zero.



Probes, Unbranded Execution, Series 160 ± 1 mm, 3,3 mm Bolt Travel, Short Body, Ø 6 mm

Compact size and robust construction makes these probes ideal for continuous use.

- Probe body Ø 6 mm.
- Clamping possible over entire length.
- Measuring bolt guided on ball bearing.
- Hard-chrome plated probe body, hardened steel.
- Protection level: IP62 as per IEC 60529.
- Executions compatible with measuring equipment from other suppliers available on request.

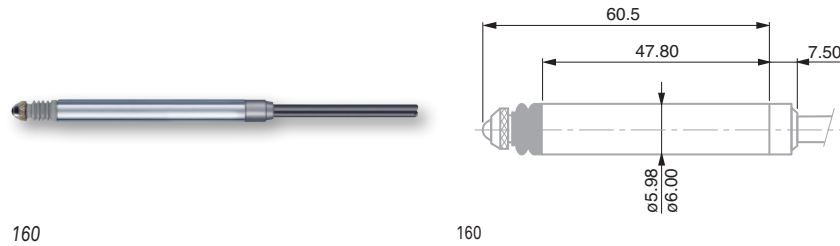

96160013	160	± 1	0,60	Mechanical	Viton

160	3,3	0,2 % (for a measuring span of ± 1 mm)	0,1	Adjustable from -1,2 to 0 (factory setting -1,08)	Axial	F96160013

* Electrical zero (N) ± 25 % deviation limit. Valid in vertical mounting position, measuring bolt lowered and in static measuring.

** For an amplitude of 10 % to the last value of the measuring range.

*** Distance from electrical zero.



DIN 32876 Part 1



See table



Nickel-plated housing. Stainless steel measuring bolt, hardened. Sealing bellows: Viton = highly resistant fluoroeelastomer.



Probe body Ø 6 mm. Measuring bolt guided on ball bearing. Distance between the lower stop and electrical zero adjustable. Interchangeable measuring insert. Thread M2. Carbide ball tip Ø 3 mm. 2 m long cable. DIN 45322 5-pin connector.



Supply frequency: 13 kHz (± 5 %) Max. mechanical frequency**: 60 Hz.



0,025 µm/°C



20 ± 0,5°C



0°C to 60°C



Protection level: IP62 (IEC 60529)



Mobile weight: 2,5 g



Transport packaging



Identification number



Probes, Unbranded Execution, Series 430 and 451, ± 0,5 mm, 1,25 et 2,10 mm Measuring Bolt Travel, Miniature

Their compact size and robust construction make them the ideal probes for a frequent use.

- Probe body Ø 8 mm.
- Clamping possible over its entire length.
- Measuring bolt on ball bearing guide.
- Hard chrome-plated probe body, hardened steel.
- Level of protection: IP62 as per IEC 60529.
- Probes compatible with measuring equipment from other suppliers also available on request.

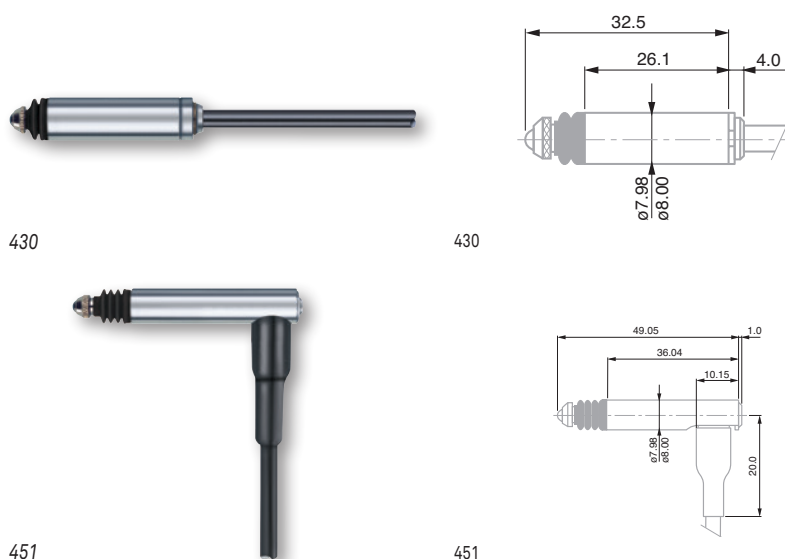

DIN 32876 Part 1



See table



Nickel-plated housing. Stainless steel measuring bolt, hardened. Sealing bellows: Nitrile = resistant elastomer.



Probe body Ø 8 mm. Measuring bolt guided on ball bearing. Adjustable distance between lower bolt and electrical zero. Interchangeable measuring insert. Thread M2,5. Carbide ball tip Ø 3 mm. Cable length: 2 m DIN 45322 5-pin connector.



Supply frequency: 13 kHz (± 5 %) Max. mechanical frequency*: 60 Hz..



0,025 µm/°C



20 ± 0,5°C



0°C to 60°C



Level of protection: IP65 (IEC 60529)



Mobile weight: 1,9 g (Series 439)
Mobile weight: 3,0 g (Series 451)



Transport packaging



Identification number

No	=	Measuring range, mm	Nominal measuring force*, N	Bolt retraction	Sealing bellows
96430029	430	± 0,5	0,75	Mechanical	Nitrile
96441041	451	± 0,5	0,60	Mechanical	Nitrile

=	Measuring bolt travel, mm	Max. permissible error for deviations in linearity, µm (L in mm)	Repeatability, µm	Setting of lower stop of measuring bolt***, mm (factory setting)	Cable output	Data sheet Nb
430	1,25	0,2 % (for a measuring span of ± 0,5 mm)	0,2	Adjustable from -0,7 to 0 (factory setting -0,58)	Axial	F96430029
451	2,10	0,2 % (for a measuring span of ± 0,5 mm)	0,1	Fixed stops (factory setting: -0,58)	Radial	F96441041

* Electrical zero (N) ± 25 % deviation limit. Valid in vertical mounting position, measuring bolt lowered and in static measuring.

** For an amplitude of 10 % to the last value of the measuring range.

*** Distance from electrical zero.



GT31 Lever Probes ± 0,3 mm, 0,3 mm Measuring Travel, Inclinable Lever



GT 31 with lever in perpendicular position

Well suited for use where probes with axial movement measuring bolts are inconvenient for measurements.

- Inclinable lever for measuring in two directions.
- Balanced lever system on ball-bearing.
- Interchangeable measuring insert, with carbide ball tip, inclinable through to 180°.
- Automatic reversal of the probing direction while the indication remains unchanged.
- Protected against shocks by 2 safety clutches.
- One-piece housing provided with 2 dovetails.
- Level of protection: IP40 as per IEC 60529.

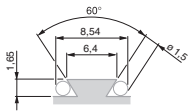

GT 31

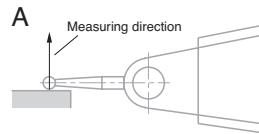

GT 31
Figure A - the leverage matches 1:1, no correction of the measured value needed

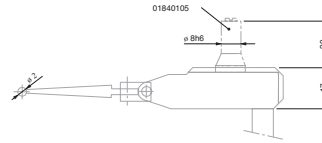

GT 31 side view and top view

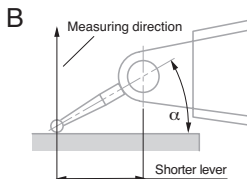

GT 31
Figure B - the leverage is no longer 1:1, correction of the measured value is needed.

Note
(Fig. A) With the insert lying parallel to the workpiece surface, the leverage matches 1:1. Therefore, no correction of the measured values is needed.
(Fig. B, angle α) Any other position will change the effective lever length, so that read values must be corrected. In this connection, please consult the instruction manual.

			Measuring range, mm	Nominal measuring force*, N	Lever retraction	Sealing bellows
03210802	GT 31	± 0,3	0,1	Without	Without bellows	Without bellows
03210801	GT 31	± 0,3	0,02	Without	Without bellows	Without bellows
03210803	GT 31	± 0,3	0,1	Without	Without bellows	Without bellows

	Measuring lever travel, mm	Max. permissible error for deviations in linearity, μm (L in mm)	Repeatability, μm	Hysteresis, μm	Setting of lower stop of the measuring insert***, mm	Cable output	Data sheet No.
GT 31	0,7	$0,2 + 50 \cdot L^2$	0,1	0,25	Fixed lower and upper stops	Angled	03200266

* Electrical zero (N) ± 25 % deviation limit. Valid in vertical mounting position, measuring bolt lowered and in static measuring.
 ** For an amplitude of 10 % to the last value of the measuring range.
 *** Distance from electrical zero.

- DIN 32876 Part 1
- ± 0,3 mm
- All-metal housing, matt-chromium finish
- 2 dovetail attachments for clamping. Both lower and upper stops are fixed. Stainless steel measuring stem. Interchangeable measuring inserts. Carbide ball tip Ø 2 mm. Cable length: 2 m. DIN 45322, 5 pin connector. Other measuring inserts available as optional accessories..
- Supply frequency: 13 kHz (± 5 %) Max. mechanical frequency**: 25 Hz.
- 20 ± 0,5°C
- 5°C to 60°C
- 80 %
- Protection level: IP40 (IEC 60529)
- Mobile weight: 12 g
- Transport packaging
- Identification number
- Declaration of conformity





DIN 32876 Part 1



See table



Hardened steel probe body, nickel-plated



Linear guidance on ball bearing, 4 M6 mounting threads. Fixed mechanical stops. Interchangeable inserts. Dovetail clamp for mounting holder. Cable length: 2 m. 5-pin connector DIN 45322.



Supply frequency: 13 kHz (± 5 %) Max. mechanical frequency**: 25 Hz.



-0,14 µm/°C



20 ± 0,5°C



-10°C to 65°C



80 %



IP50 (IEC 60529)



Mobile weight: 110 g



Transport packaging



Identification number



Inspection report with a declaration of conformity

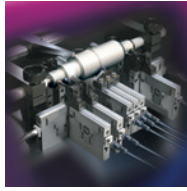

Application: Minimal space usage with FMS units placed side by side

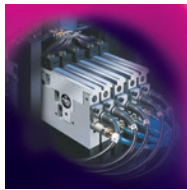

Application: small component measuring thanks to offset inserts

Probes with Parallel Guidance, ± 2 mm or ± 2,9 mm, 5,8 mm Measuring Travel

Modular construction enables the combination of elements, for example, such as springs, pneumatic cylinders and stops.

These universal probes are suited for multigauging fixtures as well as machines equipped with integrated inspection routines.

Versatility of applications:

- Probe can be used in any position for measuring.
- Measuring direction is adjustable.
- Retraction of the measuring insert is adjustable.
- Measuring force is adjustable depending on the accessory used.
- Possibility of using off-centre measuring inserts.

Unique design:

- Compact assembly noted for its robustness.
- Ball bearing guided movement.
- Wide variety of measuring inserts, holders and other accessories for measuring applications.
- LVDT execution versions compatible with melectronic equipment from other suppliers available on request.

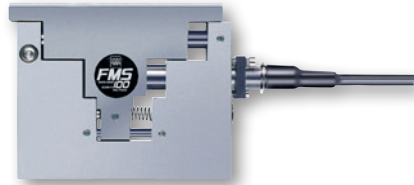

FMS 100



FMS 102

No	=	Measuring range, mm	Nominal measuring force*, N	Bolt retraction	Sealing bellows
03230019	FMS 100	± 2	2	Retraction by air pressure (optional)	Without bellows
03230049	FMS 130	± 2,9	2	Retraction by air pressure (optional)	Without bellows
03230028	FMS 102	± 2	2	Retraction by air pressure (optional)	Without bellows
03230050	FMS 132	± 2,9	2	Retraction by air pressure (optional)	Without bellows

=	Measuring bolt travel, mm	Max. permissible error for deviation in linearity, µm (L in mm)	Repeatability, µm	Hysteresis, µm	Setting of lower stop of measuring bolt***, mm	Cable output	Data sheet No.
FMS 100	5,8	0,2 + 3 · L ³	0,5	0,5	Fixed stops: lower -2,9 upper +2,9	Parallel	03200253
FMS 130	5,8	0,2 + 3 · L ³	0,5	0,5	Fixed stops: lower -2,9 upper +2,9	Parallel	03200342
FMS 102	5,8	0,2 + 3 · L ³	0,5	0,5	Fixed stops: lower -2,9 upper +2,9	Parallel	03200254
FMS 132	5,8	0,2 + 3 · L ³	0,5	0,5	Fixed stops: lower -2,9 lower +2,9	Parallel	03200343

* Electrical zero (N) ± 25 % deviation limit. Valid in vertical mounting position, measuring bolt lowered and in static measuring.

** For an amplitude of 10 % to the last value of the measuring range.

*** Distance from electrical zero.



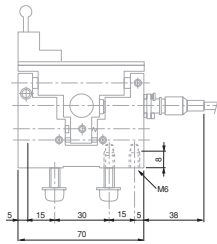

FMS 100

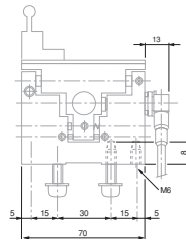

FMS 102

Configuration and Application of TESA FMS Probes

Shown below are the different possibilities for the activation and retraction of the probe insert during measurement cycles.

APPLICATION EXAMPLE A

- Activation of the probe insert in the direction of the part to be inspected using the measuring force produced by the spring set.
- Without retraction of the insert.

Result A

During the placing of a new part to be measured, the measuring insert remains in its contact position thanks to the measuring force produced by the spring set.

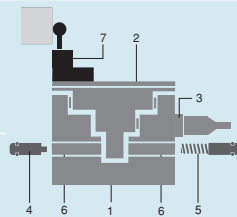

- 1 Static probe body
- 2 Mobile probe body
- 3 Measuring element with fine adjust
- 4 Adjustable stop
- 5 Spring set for producing measuring force
- 6 M6 mounting thread
- 7 Holder

APPLICATION EXAMPLE B

- Activation of the probe insert in the direction of the part to be measured using the measuring force of the spring set.
- Retraction of the insert by pneumatic pressure through a pneumatic connection.

Result B

During the placing of a new part to be measured, the measuring insert is retracted through activation of pressure via the pneumatic actuator.

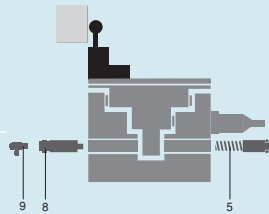

- 5 Spring set for producing measuring force
- 8 Pneumatic actuator (Part No. 03260440)
- 9 Connector (Part No. 024388)

APPLICATION EXAMPLE C

- Activation of the probe insert in the direction of the part to be inspected by pneumatic pressure and the measuring force of the spring set.
- Retraction of the insert by disabling the pneumatic pressure.

ATTENTION !

The force of the spring set (5) must be equal to that of the auxiliary spring element (10).

Result C

During the placing of a new part to be measured, the measuring insert is automatically retracted due to the disabling of the pneumatic pressure, which guarantees about security during the measuring cycle.

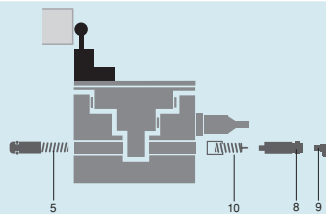

- 5 Spring set for producing measuring force
- 8 Pneumatic actuator (Part No. 03260440)
- 9 Connector (Part No. 024388)
- 10 Auxiliary spring element (Part No. 03260445)

This configuration is typically preferred when there is lack of space for connecting a pneumatic actuator (left side of example B).





DIN 32876 Part 1



See table



Hardened steel probe body, nickel-plated



Linear guidance on ball bearing. 4 M6 mounting threads.. Fixed mechanical stops.. Interchangeable inserts. Holder with dovetail clamping. Cable length: 2 m. 5-pin connector DIN 45322.



Supply frequency: 13 kHz (± 5 %). Max. mechanical frequency**: 25 Hz.



-0,14 µm/°C



20 ± 0,5°C



-10°C to 65°C



80 %



IP54 (IEC 60529)



Mobile weight: 110 g



Shipping packaging



Identification number



Inspection report with a declaration of conformity



Application: measurement with a protected FMS



FMS 102-P



FMS 100-P

Probes with Parallel Guidance, ± 2 mm or ± 2,9 mm, 5,8 mm Measuring Travel – Protected Version

- FMS 100-P, 102 -P, 130-P, 132-P provide dust protection of the 2 side faces.

Modular concept for combining elements, for example, such as springs, pneumatic actuators and stops.

These universal probes are suitable for mutigauging inspection fixtures as well as machines with integrated automated inspection routines.

Versatility of applications:

- Probe can be used in any position for measuring
- Measuring direction can be changed
- Retraction of the measuring insert is adjustable
- Measuring force is adjustable, depending on the accessory used
- Possibility of using off-centre measuring inserts

Unique design:

- Compact assembly noted for its robustness
- Ball bearing guided movement
- Wide variety of measuring inserts, holders and other accessories for measuring applications
- LVDT execution versions compatible with melectronic equipment from other suppliers available on request.

No	=	Measuring range, mm	Nominal measuring force*, N	Bolt retraction	Sealing bellows
03230037	FMS100-P	± 2	2	Retraction by air pressure (optional)	Without bellows
03230051	FMS130-P	± 2,9	2	Retraction by air pressure (optional)	Without bellows
03230038	FMS102-P	± 2	2	Retraction through air pressure (optional)	Without bellows
03230052	FMS132-P	± 2,9	2	Retraction through air pressure (optional)	Without bellows

	Measuring bolt travel, mm	Max. permissible errors for deviations in linearity, µm (L en mm)	Repeatability, µm	Hysteresis, µm	Setting of lower stop of measuring bolt***, mm	Cable output	Data sheet No.
FMS100-P	5,8	0,2 + 3 · L ³	0,5	0,5	Fixed stops: lower -2,9 upper +2,9	Parallel	03200283
FMS130-P	5,8	0,2 + 3 · L ³	0,5	0,5	Fixed stops: lower -2,9 upper +2,9	Parallel	03200344
FMS102-P	5,8	0,2 + 3 · L ³	0,5	0,5	Fixed stops: lower -2,9 upper +2,9	Angled	03200289
FMS132-P	5,8	0,2 + 3 · L ³	0,5	0,5	Fixed stops: lower -2,9 upper +2,9	Angled	03200345

* Electrical zero (N) ± 25 % deviation limit. Valid in vertical mounting position, measuring bolt lowered and in static measuring.

** For an amplitude of 10 % to the last value of the measuring range.

*** Distance from electrical zero.



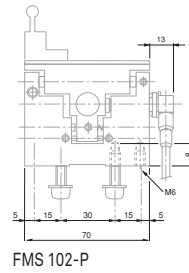
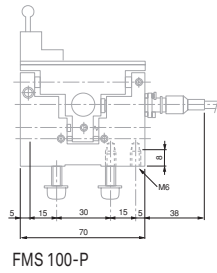

Configuration and Application of TESA FMS Probes

Shown below are the different possibilities for the activation and retraction of the probe insert during measurement cycles.

APPLICATION EXAMPLE A

- Activation of the probe insert in the direction of the part to be inspected using the measuring force produced by the spring set.
- Without retraction of the insert.

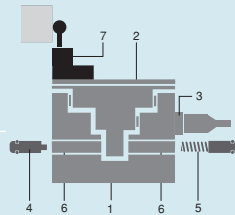

- 1 Static probe body
- 2 Mobile probe body
- 3 Measuring element with fine adjust
- 4 Adjustable stop
- 5 Spring set for producing measuring force
- 6 M6 mounting thread
- 7 Holder

Result A
During the placing of a new part to be measured, the measuring insert remains in its contact position thanks to the measuring force produced by the spring set.

APPLICATION EXAMPLE B

- Activation of the probe insert in the direction of the part to be measured using the measuring force of the spring set.
- Retraction of the insert by pneumatic pressure through a pneumatic connection.

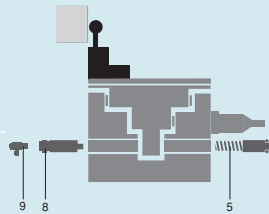

- 5 Spring set for producing measuring force
- 8 Pneumatic actuator (Part No. 03260440)
- 9 Connector (Part No. 024388)

Result B
During the placing of a new part to be measured, the measuring insert is retracted through activation of pressure via the pneumatic actuator.

APPLICATION EXAMPLE C

- Activation of the probe insert in the direction of the part to be inspected by pneumatic pressure and the measuring force of the spring set.
- Retraction of the insert by disabling the pneumatic pressure.

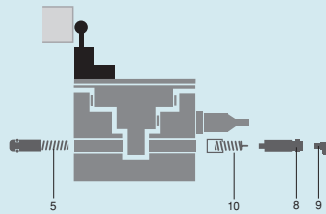

- 5 Spring set for producing measuring force
- 8 Pneumatic actuator (Part No. 03260440)
- 9 Connector (Part No. 024388)
- 10 Auxiliary spring element (Part No. 03260445)

ATTENTION !
The force of the spring set (5) must be equal to that of the auxiliary spring element (10).

Result C
During the placing of a new part to be measured, the measuring insert is automatically retracted due to the disabling of the pneumatic pressure, which guarantees about security during the measuring cycle.

This configuration is typically preferred when there is lack of space for connecting a pneumatic actuator (left side of example B).



TESATRONIC TT10 Probe Display Unit

- Perfect for inspection on the surface plate, on an inspection work station in production or directly on a machine.
- Battery power supply.
- Can be used wherever the presence of a power cable can inhibit measuring operations.
- Frequently used with a GT 31 lever probe for setting operations.
- Simple-to-use function keys and easy reading of the combined digital/ analogue indication.
- Liquid crystal (LCD) indication display. No pointer which ensures an excellent repeatability and negligible hysteresis.
- 3 measuring ranges, switchable manually or automatically depending on the measured value.
- Metric/inch conversion.
- Signal amplification (5x) for easy display setting.
- Quick zero-setting with the help of a touch key thanks to digital technology.
- Signal input for one probe.
- Opto-coupled RS232 compatible digital output.



TT10



TT10 with template

- DIN 32876 Part 1
- Circular scale Ø 40 mm
- 3-decade display plus minus sign
- 9 x 4,5 mm
- 66 x 57 mm LCD display size
- Value limit for a temperature of 20°C and a relative humidity of ≤ 50 %: Analogue display: 2 % Digital display: 2 %
- ± 1 digital step
- 95 x 170 x 68 mm (W x D x H)
- Resistant plastic material
- For a temperature of 20°C and a relative humidity of ≤ 50 %: Analogue and digital response time: ≤ 100 ms. Holding of digital display: ≥ 100 ms.
- For a temperature of 20°C and a relative humidity of ≤ 50 %: Zero drift and signal amplification: ≤ 0,005 %/°C. Display frequency limit with respect to input signal: 10 Hz
- Opto-coupled RS232
- Supply: 3,5 V to 4,5 V, 3 batteries AA 1,5 V, type LRC 6. Power consumption: ≈ 7 mW/3,5 V Probe supply voltage: 0,7 V Supply frequency: 13 ± 0,65 kHz









	Number of probes inputs	Automatic conversion of range
TESATRONIC TT10 portable display unit for TESA inductive probes	1	●

		Measuring range zoom x5	Memory
04430008	TESATRONIC TT10 portable display unit for TESA inductive probes	●	–





With a measuring support

-  0°C to 60°C
-  -10°C to 70°C
-  80 %, without condensation
-  Level of protection: IP42 (IEC 60529)
-  EN 500081-1
EN 500081-2
EN 500082-1
EN 500082-2
-  490 g (including batteries)
-  Transport packaging
-  Identification number
-  Declaration of conformity

STANDARD ACCESSORIES:

- | | |
|-----------------|---|
| 04768002 | 3 AA 1,5 V batteries, type LRC 6 for TT10 |
| 04460007 | 10x templates for TT10 |



With a measuring support

OPTIONAL ACCESSORIES:

- | | |
|-----------------|--|
| 04768000 | Hand switch for manually triggering data transfer. Jack plug connector, 1,8 m
- TESA SPC PRINTER printer
- TESATRONIC TT display units |
| 04768001 | Foot switch for triggering data transfer. Jack plug, 1,8 m
- TESA SPC PRINTER printer
- TESATRONIC (TT) display units |
| 04761023 | Cable: miniDIN 8p/m to Sub-D 9p/f, 2m
for TT10 and MICRO-HITE manual versions 10/11/12 |
| 04761024 | Cable: miniDIN 8p/m to Sub-D 25p/m, 2m
for TT10 and MICRO-HITE manual versions 10/11/12 |



TESATRONIC TT20 and TT60 Probe Display Units

- DIN 32876 Part 1
- 110 mm scale length
- 50 scale divisions
- 6-decade display plus minus sign
- 12,5 x 6,6 mm
- 126 x 62 mm LCD display
- Value limit for a temperature of 20°C and a relative humidity of ≤ 50 %
 TT20:
 Analogue display: 2%
 Digital display 0,3%
 Digital output: 0,3%
 TT60:
 Analog display: 2%
 Digital display: 0,3%
 Analogue output: 0,3%
 Digital output: 0,3%
- ± 1 numerical interval
- 255 x 235 x 120 mm (W x D x H)
- Resistant plastic material
- For a temperature of 20°C and a relative humidity of ≤ 50 %:
 TT20:
 Response time of analogue, digital and LED classification displays: ≤ 80 ms.
 Maintenance of digital display: 80 ms.
 TT60:
 Response time of analogue, digital and LED classification displays: ≤ 80 ms.
 Holding of digital display: 80 ms.
 Response time of the analogue output signal in relation to analogue display: ≤ 30 ms.

- Functional reliability.
- User-friendly.
- Essential for inspection in production or metrology laboratory.

TESATRONIC TT20

Combined digital and analogue indication

2 probe inputs for single measurements, sum and difference measurements

- Large LC display for comfortable and error-free reading.
- Pseudo-analogue bargraph indication for a better repeatability and negligible hysteresis.
- Choice between pointer or bargraph indication.
- LCD display for all functions.
- 7 measuring ranges, switchable manually or automatically according to the measured value.
- Direct conversion from metric to inch units.
- Touch button for the indication setting of of each measuring channel.
- Keys for introducing limit values.
- Classification of values (3 classes) and display through colour LEDs with signal outputs.
- Locking of displayed values for step by step measurement routines.
- Automatic recognition of the type of connected TESA probe with adaptation of the measurement signals to the value of output connected (valid only for TESA probes produced from 1997 onwards).
- Opto-coupled RS232 output, bidirectional.
- Power supply through mains adapter.

TESATRONIC TT60

Same features as TESATRONIC TT20, but with following added functions:

- Memory for retaining extreme values "max.", "min.", "max.-min." along with mean value obtained from "max." minus "min.".
- Dynamic measurement with acquisition of >100 single values.
- Value classification with output signals through contact relay for 5, 10, 20 or 40 acceptable classes.
- Analogue output for exterior processing of signals.





TT60



TT20

No	=	* (Measuring range zoom x5)	* (Memory)
04430009	TESATRONIC TT20 Display unit for 1 or 2 inductive probes	-	-
04430010	TESATRONIC TT60 Display unit for 1 or 2 inductive probes	-	●



	 Number of probe inputs	 Automatic switching of range
TESATRONIC TT60 Display unit for 1 or 2 inductive probes		●
TESATRONIC TT20 Display unit for 1 or 2 inductive probes		●

DELIVERED WITH THE FOLLOWING ACCESSORIES:

04761054	Battery charger 100 ÷ 200 VAC 50 ÷ 60 Hz, 6,6 V DC, 750 mAh supplied without power cable
04761055	Mains cable EU for charger 0471054

OPTIONAL ACCESSORIES:

04768000	Hand switch for manually triggering data transfer. Jack plug connector, 1,8 m – TESA SPC PRINTER printer – TESATRONIC TT display units
04768001	Foot switch for triggering data transfer. Jack plug, 1,8 m – TESA SPC PRINTER printer – TESATRONIC (TT) display units
04761062	Opto-USB cable, Duplex, 2m Bidirectional communication
04761049	Opto-RS cable, Duplex, 2m Bidirectional communication

 For a temperature of 20°C and a relative humidity of ≤ 50 %:
TT20:
Response time of analogue, digital and LED classification displays: ≤ 80 ms.
Maintenance of digital display: 80 ms.
TT60:
Response time of analogue, digital and LED classification displays: ≤ 80 ms.
Holding of digital display: 80 ms.
Response time of the analogue output signal in relation to analogue display: ≤ 30 ms.

 RS232 opto-coupled output

 TT60: Voltage Range: ± 2 V to ± 10 V. Output current: ≤ 2 mA. Load adjustment: ≥ 5 kΩ. Background noise (probe at electrical zero) ≤ 1 mV. Reference potential: ground 0 V.

 Supply: 6,5 V DC up to 7,3 V DC. Supply frequency: 13 ± 0,65 kHz. Power consumption: 2 W. Monitored voltage variations. Probe supply voltage: 3 V.

 0°C to 60°C

 -10°C to 70°C

 80 %, without condensation

 Protection of frontal face: IP54 (IEC 60529, DIN 40 050)

 IEC/EN 61326-1
USA: CFR47, Part 15, Subpart B, Class B, Digital Device

 1,1 kg

 Transport packaging

 Identification number

 Declaration of conformity



TESATRONIC TT 80 and TT 90 Probe Display Units

- DIN 32876 Part 1
- 110 mm scale length
- 50 scale divisions
- 6-decade display plus minus sign
- 12,5 x 6,6 mm
- 126 x 62 mm LCD display
- Limit value for a temperature of 20°C and a relative humidity of ≤ 50 %:
Analog display: 2 %
Digital display: 0,15 %
Analog output: 0,3 %
Digital output: 0,15 %
- ± 1 digital interval
- 255 x 235 x 120 mm (W x D x H)
- Resistant plastic

High resolution display units

Combined analogue/digital display

Two probe inputs for single, sum and difference measurements.

In addition to TESATRONIC TT60 functions, TT 80 has the following additional functions:

- 9 measuring ranges with digital steps of 0,01 µm or 0.000001 in.
- Memorisation of extreme values "max.", "min.", "max. minus min." as well as the mean of the two values "max." and "min."
- Dynamic measurement with acquisition of more than 10 single values per second.
- Classification of measured values with a contact relay providing output signals for 5, 10, 20 or 40 acceptable classes.
- Analogue output for external processing of signals.

In addition to TESATRONIC TT60 functions, TT 90 has the following additional functions:

- 9 measuring ranges with digital step of 0,01 µm or 0.000001 in.
- Memorisation of extreme values "max.", "min.", "max. minus min." plus the mean of both values "max." and "min."
- Dynamic measurement with acquisition of more than 10 single values per second.
- Classification of measured values with output signals through contact relay for 5, 10, 20 or 40 acceptable classes.
- Analogue output for external signal processing.
- Output for bolt retraction control.
- Selection of stabilisation time for measuring cycles.
- RS digital output for values to the micron.



TT 90



TT 80



Application: TT 80 with a SIP (Société genevoise d'instruments de physique) high precision measuring bench

No	=		
		Measuring range zoom x5	Memory
04430011	TESATRONIC TT80 High precision electronic display	-	●
04430012	TESATRONIC TT90 High precision electronic display	-	●

=		
	Number of probes inputs	Automatic conversion of range
TESATRONIC TT80 High precision electronic display	2	●
TESATRONIC TT90 high precision electronic display	2	●





DELIVERED WITH THE FOLLOWING ACCESSORIES:

04761054	Battery charger 100 ÷ 200 VAC / 50 ÷ 60 Hz, 6,6 V DC, 750 mAh, supplied without power cable
04761055	Mains cable EU for charger 0471054

OPTIONAL ACCESSORIES:

04768000	Hand switch for manually triggering data transfer. Jack plug connector, 1,8 m - TESA SPC PRINTER printer - TESATRONIC TT display units
04768001	Foot switch for triggering data transfer. Jack plug, 1,8 m - TESA SPC PRINTER printer - TESATRONIC (TT) display units
04761062	Opto-USB cable, Duplex, 2m Bidirectional communication
04761049	Opto-RS cable, Duplex, 2m Bidirectional communication

 For a temperature of 20°C and a relative humidity of ≤ 50 %: Response time analogue, digital and LED displays classification: ≤ 100 ms. Holding of digital display: 100 ms. Response time of the analogue output signal in relation to analogue display: ≤ 30 ms.

 For a temperature of 20°C and a relative humidity of ≤ 50 %: Zero drift and signal amplification: ≤ 0,005 %/°C. No drift of stored values. Frequency limit for all displays frequency, analog output and memory in relation to input signal: 10 Hz

 RS232 opto-coupled output

 Voltage range of ± 2 V to ± 10 V. Output current: ≤ 2 mA. Load adjustment: ≥ 5 kΩ. Background noise (probe to 0 electric) ≤ 1 mV. Reference potential: analog ground 0 V

 6,5 Vdc up to 7,3 V DC. Consumption: 2 W. Monitored voltage fluctuation. Supply voltage for probe: 3 V

 0°C to 60°C

 -10°C to 70°C

 80 %, without condensation

 Protection of frontal face: IP54 (IEC 60529, DIN 40 050)

 IEC/EN 61326-1 USA: CFR47, Part 15, Subpart B, Class B, Digital Device

 1,1 kg

 Transport packaging

 Identification number

 Declaration of conformity



TESATRONIC TTA20 Probe Display Unit

Compact design with analogue indication and value classification of measured values.

Aluminium housing, designed for shop floor applications, user-friendly.

- Easy-to-read analogue display with mirror strip in order to avoid parallax error.
- 6 measuring ranges.
- Metric/Inch conversion.
- Zero setting potentiometer for display.
- 2 probe inputs for single, sum or difference measurements.
- 1 auxiliary signal input, e.g. for all correction values.
- Colour LEDs of green for "Good", yellow for "Rework" and red for "Scrap".
- Potentiometer for setting limit tolerances.
- Polarity reverse switch for classification signals (internal or external dimensions).
- Switch for locking or unlocking a displayed value.
- Analogue output for a display unit or external recording.



TTA20



DIN 32876 Part 1



Length: 100 mm



Limit value for a temperature of 20°C and a relative humidity of ≤ 50 %: Analog Display: 1,5 % Analog output: 0,3 %



Display: negligible. Classification signals: 5 %



258 x 190 x 158 mm (W x D x H)
Die-cast aluminum case, designed for the workshop



For a temperature of 20°C and a relative humidity of ≤ 50 %: Response time of the analogue display: ≤ 1 ms. Response time of the analogue output signal from the analog display: 20 ms. Response time for classification signals: 10 ms.



For a temperature of 20°C and a relative humidity of ≤ 50 %: Zero drift: ≤ ± 0,005 % /°C. No drift of stored values. Frequency limit for analogue display: 1 Hz. Frequency limit for analogue output: 50 Hz. Frequency limit for classification: 30 Hz

No	=		❄	❄	❄
		Number of measuring ranges Min range / Max range max (µm)	Measuring range zoom x5	Memory	Power supply
04430003	TTA20	6 / min ± 3 max ± 1000	-	-	Network

DELIVERED WITH THE FOLLOWING ACCESSORIES:

03160015	Mains cable CH 2 m
03160016	Mains cable, EU, 2 m
03160017	Mains cable without plug, 2 m for TTA20

OPTIONAL ACCESSORY:

04460004	Connector 15 pins for analogue output and classification signal of TTA20
----------	--

µm	µm	in	in
± 1000	50	± 0.1	0.005
± 300	10	± 0.03	0.001
± 100	5	± 0.01	0.0005
± 30	1	± 0.003	0.0001
± 10	0,5	± 0.001	0.00005
± 3	0,1	± 0.0003	0.00001

A	❄
Number of probe inputs	Automatic conversion of range
2	-



Accessories for TESATRONIC TT Units



04761055



04761056



04761054



03160017



03160015



03160016



Template for TT10 display

Voltage: ± 1 V. Output current ≤ 3 mA. Adjustment load ≥ 2 k Ω . Residual ripple (at electrical zero): ≤ 1 mV. Reference potential: analogue ground 0 V

Supply voltage 230 or 115 V -10% to +20%, 50-60 Hz. Virtual power: 20 VA. Supply voltage for probe: 1,5 Vrms -10% to +5%. Frequency: 13 kHz $\pm 0,5$ %.

0°C to +50°C

-10°C to +70°C

Level of protection: IP40 (IEC 60529)

EN 50081-1
EN 50081-2
EN 50082-1
EN 50082-2

3,4 kg

Transport packaging

Identification number

Declaration of conformity

No

=

04761054	Battery charger 100 ÷ 200 VAC 50 ÷ 60 Hz, 6,6 V DC, 750 mAh supplied without power cable
04761055	Mains cable EU for charger 0471054
04761056	Mains cable US for charger 0471054
03160015	Mains cable CH, 2 m for TTA20
03160016	Mains cable EU, 2 m for TTA20
03160017	Mains cable without plug, 2 m for TTA20
04460007	10x templates for TT10
04460004	Connector 15 pins for analogue output and classification signal of TTA20
04768002	3 AA 1,5 V batteries, type LRC 6 for TT10



ELECTRONIC INTERFACE UNITS

Electronic interfaces to manage, synchronize inductive probes and allow data transfer to a computer or an automatic inspection machine.

TESA Probe Interface Boxes - BPX Series

Modular system available in 2 versions (BPX and TWIN-STATION) for the conversion of measured signals to digital values and transmission of these values to a computer. These units are key components for multigauging inspection fixtures for centralised process control systems.

Signal inputs – 1 to 4 TESA standard half-bridge probes.

Signal output – digital, RS232 through USB port.

- Direct connection to the computer's USB port.
- Stand Alone operating mode: program routine via the computer, enabling the BPX box to execute a simple measuring function with classification signal relay via connector Sub-D 15P.
- Optimal adaptation for various measuring applications, for example, connection of 16 probes thanks to serial USB connections on 4 BPX boxes.
- Increased functional reliability and high precision.
- Increased immunity to negative environmental effects, whether of electrical origin or provoked by liquid and solid contaminants.
- BPX is compatible and can be used with TWIN-STATION.
- TIS interface software is included in the BPX (part number 05030012) for display of measured values. Possibility of indicating tolerance values, and simple functions +A, -A, +A+B, +A-B, export of values to a .csv file.



BPX Front

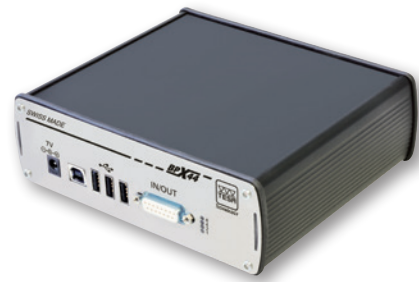

BPX Rear



TIS software included in the BPX supply

- ±2 mm, ±5 mm
- 0,1 µm
- Field error indication (pictogram / text) to a temperature of 20°C and a relative humidity of ≤ 50 %: Digital output: ±(0,05 + 0,15 % of range)
- 55 x 172 x 155 mm (H x W x D)
- Housing in aluminium
- For a temperature of 20°C and a relative humidity of ≤ 50 %: Zero drift: ≤ ± 0,05 %/°C. Sensitivity drift: ≤ ± 0,05 %/°C. Acquisition time: 10 ms (between two consecutive measurements) 1 ms (timing window) time data transfer of digital serial output (USB): depends on the operating system of the computer.
- USB port (USB Hub) Communication: USB 2.0, 3 external ports (≤ 100 mAh)
- Supply voltage of the charger: 115 to 230 Vrms, charger frequency 50 ÷ 60 -10 to +15 % Hz
- 10°C to 40°C
- 10°C to 70°C
- 80 %, without condensation
- IP40 (IEC 60529) (DIN 40050)
- IEC/EN 61326-1 U.S. 47 CFR part 15, subpart B, Class B digital device
- 1 kg (BPX) 0,85 kg (TWIN Station)
- Power supply 100 ÷ 240 V, 50 ÷ 60 Hz (04761054) EU Cable, CH (04761055) U.S. Cable (04761056)
- Packed suitable for transport
- Identification number
- Declaration of conformity

No	A	✳	✳
05030010	Number of probe inputs 4	Number of I / O (In / Out) controllers 1 / 3	Connector Sub-D 15 p/f (for In/Out signals)



TWIN-STATION Receiver for TESA Wireless Probes



GTL 21 W wireless probe with VERIBOR (optional)

Modular system available in 2 executions (TWIN Station and BPX) for the conversion of inductive probe signals into digital values for transmission to a computer. These units are important components for measuring fixtures requiring freedom of movement without any constraints and without any cables, a wireless transmission

Signal inputs – 1 to 8 TESA half-bridge wireless probes*

Signal outputs – digital, RS232 through USB port

- Direct connection to the USB port of the computer.
- Perfect fit for your metrology applications through the connection of up to 32 wireless probes by means of serial USB to 4 TWIN-Station units.
- Great functional reliability and high accuracy.
- TWIN Station is compatible and can be used with BPX.
- TIS interface software TIS included in supply of TWIN-STATION (part no. 05030012): display of measured values. Possibility of indicating tolerances, simple functions +A, -A, +A+B, +AB, and export of values to a .Csv file.

Note: The sale of TWIN-STATION is limited to EU countries, Switzerland, USA and Canada.

* The sale of wireless probes is limited to EU countries, Switzerland, USA, Canada and China.



TWIN Station, front



TWIN Station, rear

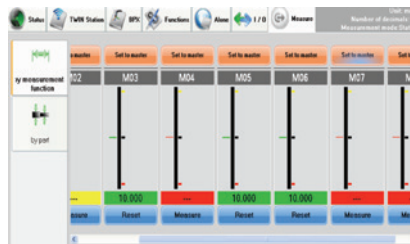

TIS Software, included in the Twin Station supply

- ± 2 mm, ± 5 mm
- 0,1 µm
- For a temperature of 20°C and a relative humidity of ≤ 50 %: Digital output: ± (0,05 + 0,15 % of measuring range)
- 55 x 172 x 155 mm (H x W x D)
- Housing case in aluminium
- For a temperature of 20°C and a relative humidity of ≤ 50 %: Zero drift: ≤ ± 0,05 %/°C. Sensitivity drift: ≤ ± 0,05 %/°C. Acquisition time: 20 ms (between two consecutive measurements) 2 ms (timing window) Time for data transfer from digital serial output (USB): depends on the operating system of the computer
- Power supply via USB cable connection – directly to PC (USB port) – to a USB-connected hub – to a BPX probe interface (05030010)
- 10°C to 40°C
- 10°C to 60°C
- 80 %, without condensation
- IP40 (IEC 60529) (DIN 40050)
- IEC/EN 61326-1 U.S.47 CFR part 15, subpart B, Class B digital device
- 0,85 kg
- USB cable, 1,80 m
- Transport packaging
- Identification number
- Declaration of conformity

	Number of wireless probes per TWIN Station	Power supply	Weight, kg
05030012	1-8	Power supply via: – USB port of PC – USB-connected hub – BPX	0,85



± 0,5% with reference to the measuring span



± 10 to ± 15 V DC, 60 mA



≤ ± 100 ppm/°C, stability at zero = ≤ ± 0,2 μm/°C



15°C to 40°C



-10°C to 70°C



30% to 80 %, without condensation



IP50 (IEC 60529)



Transport packaging

TESA Probe Interface Boxes with Analogue Output – Series M4P-2

Signal inputs – TESA standard execution probes (Half-bridge)

Signal outputs – analogue (in ± V/mm)





- Connection of up to 32 TESA standard half-bridge probes.
- Connection possible to a PC through the A/D transducer.

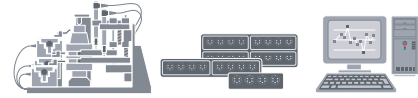

Rack with 3 M4P-2 interfaces



Multi-gauging fixture with 1, 2 or 4 M4P-2 interfaces

No	=					
		Sensitivity (mV / V / mm)	Number of probe inputs	Dimensions (mm)	Analogue outputs	Weight (kg)
S48001721	M4P-2 interface 4 probe inputs with demodulator and analogue output in V/mm	73,75	4, including a demodulator	36 x 100 x 120	± 1 V/mm, ± 2,5 V/mm, ± 5 V/mm, ± 10V/mm	0,6
S48001722	R2M-1 rack for 2x M4P-2	–	8 (with 2x M4P-2)	55 x 212 x 144	–	0,9
S48001723	R4M-1 rack for 4x M4P-2	–	16 (with 4x M4P-2)	160 x 212 x 144	–	1,2
S48001724	Supply module MA4-2, 230V	–	Voltage: 230 ± 10 % Vac, 50 Hz	85 x 222 x 146	Output voltage: ± 15V for 32 probes	1,1
S48001731	Power supply MA4-2, 110 V	–	Voltage: 110 ± 10 % Vac, 60 Hz	85 x 222 x 146	Output voltage: ± 15V for 32 probes	1,1

Accessories for M4P-2 probe interface

No	=
S48001725	M4P-2 connecting cable to PC, 2m DB-37 pins m/f



Adaptor Cable: DIN 5p Connector to USB Type A Connector

Allows for quick and easy connection of any TESA standard half bridge probe to a PC USB port.

Signal inputs – TESA standard probes (Half-bridge)
 Signal outputs – digital RS 323 through USB port

No	=			
		Measuring range, mm	Deviation span of indication	Zero drift
03260500	Cable adapter DIN 5p for USB. enables connection of TESA probes sensitivity 73,75 mV/V/mm directly to a USB port	± 2 mm	0,3 % ± 0,1 µm	± 0,01 %/°C
03260501	Cable adapter DIN 5p for USB. enables connection of TESA probes sensitivity 29,50 mV/V/mm directly to a USB port	± 5 mm	0,3 % ± 0,1 µm	± 0,01 %/°C



Cable adapter: DIN 5-pin connector to USB connector type A

- DIN 32876 Part 1
- 0.1 µm
- 2 V effectively
13 kHz ± 0,5 %
- At 20°C and relative humidity ≤ 50 %:
error of indication = 0,3 % ± 0,1 µm zero drift ± 0,01 %/°C V.
Standard refresh speed = 80 ms.
Maximum refresh speed = 42 ms.
Distance between the stops and the electrical zero cannot be adjusted.
Length of cable: 1,2 m. Note: the total error should take into account the error of the probe and the error of the adapter.
- USB 2.0 RS232, virtual COM port
- See table
- 20 ± 0,5°C
- 10°C to 40°C
- 80 %
- IP51 (IEC 60529)
- Packed suitable for shipping
- Serial number identification



Calibration Standards – Dummy Probes

Calibration standards – also known as "dummy probes" – are resistance dividers. Each calibration standard simulates a given length dimension with high accuracy. Each calibration standard has 2 values (positive and negative). The values indicated below are the nominal values.

These products are calibrated and supplied with an inspection report that shows the values (actual values) measured during calibration and the related measuring uncertainty.

The calibration standards are connected to the instrument in place of regular probes. For the calibration and all required setting operations of the instrument, certain criteria and conditions need to be respected. Consult the user manual or get in touch with our specialists for further information.



Set of 3 calibration standards (S41077249)



Input impedance
 $970 \pm 50\Omega$ (13 kHz)
 or $2150 \pm 50\Omega$
 (standard $0 \mu\text{m}$)
 Phase (13 kHz):
 $71 \pm 2^\circ$. Input
 resistance:
 $100 \pm 5\Omega$. Output
 impedance at
 13 kHz: $1000 \pm 2\Omega$.
 Phase (13 kHz): $0,2^\circ$
 Dummy probe (half-
 bridge), sensitivity
 $73,75 \text{ mV/V/m}$.
 Suitable for
 instruments with
 following features:
 Frequency: 13
 $\pm 0,65 \text{ kHz}$, Voltage:
 $3 \pm 0,015 \text{ Veff}$ (2
 symmetrical voltages
 of $1,5 \text{ Veff}$) Input and
 output impedance:
 $\leq 0,2\Omega$ et 2000Ω ,
 respectively



-10°C to 70°C



10°C to 35°C



Calibration: 40 % to
 60 %. Operating:
 20 % to 80 %.
 Storage: 5 % to
 95 %. Without
 condensation.



IP40 (IEC 60529)



Inspection report



$\varnothing 18 \text{ mm}$, length
 118 mm



$\approx 45 \text{ g}$



$20 \pm 0,5^\circ\text{C}$, stabilisa-
 tion time = 8 h



$\pm 3 \text{ ppm}/^\circ\text{C}$. Ageing:
 $\pm 30 \text{ ppm/a}$

No

=

Value of the calibration stan-
 dard (microns)

S41078077	Dummy probe	± 0
S41078079	Dummy probe	± 3
S41078228	Dummy probe	± 100
S41078230	Dummy probe	± 190
S41078087	Dummy probe	± 300
S41078332	Dummy probe	± 500
S41078751	Dummy probe	± 1000
S41078752	Dummy probe	± 1900
S41077249	Set of 3 dummy probes	$\pm 0 / \pm 100 / \pm 1000$
S41078654	Set of 2 dummy probes	$\pm 190 / \pm 1900$



INSERTS FOR AXIAL PROBES, WITH M2 THREAD

Extensions for Inserts with M2 Thread

No		L, mm
03540505		10
03540506		15

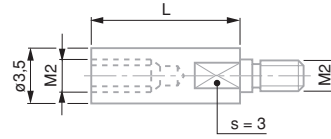

03540505, 03540506

Measuring Insert with Cylindrical Measuring Face, Lock Nut for Radial Alignment, M2 Thread

No			L, mm
03510503	Carbide		6

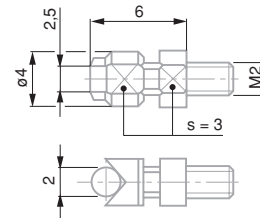

03510503

Hemispherical Measuring Inserts, M2 Thread

No			R, mm	Material	L, mm
03510204			R 1	Carbide	3
03510103			R 5	Carbide	3

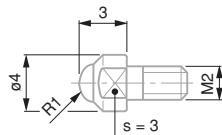

03510204

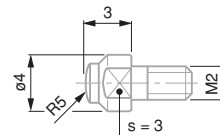

03510103

Spherical Measuring Inserts, R = 5 mm, M2 Thread

No			L, mm
03510202	Carbide		16
03510203	Carbide		26

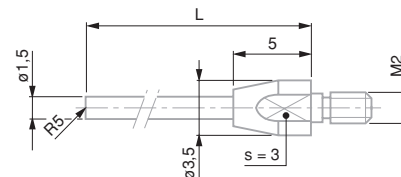

03510202, 03510203



INSERTS FOR AXIAL PROBES, WITH M2,5 THREAD

Extensions for Measuring Inserts, $\varnothing 4$ mm, 10 – 40 mm

No		L, mm
03540501		10
03540502		15
03540503		20
03540504		40

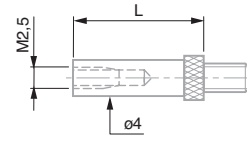

03540501 to 03540504

Standard Spherical Measuring Inserts, $R = 1,5$ mm, $L = 6$ mm

No				L, mm
03510001	L=6 mm	Steel		6
03510002	L=6 mm	Carbide		6
03560001	L=6 mm	Sapphire		6

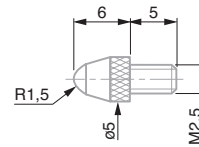

03510001, 03510002, 03560001

Spherical Measuring Insert with 4 Interchangeable Pins, $R = 1,5$ mm, Length 16-46 mm

No			L, mm
03510201	Steel		16, 26, 36, 46

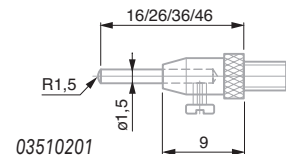

03510201

Spherical Measuring Inserts, $R = 5$ mm, $L = 6$ mm

No			L, mm
03510101	Steel		6
03510102	Carbide		6

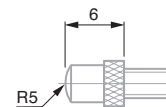

03510101, 03510102

Insert with Cylindrical Measuring Face, Counter Nut for Radial Alignment

No			L, mm
03510502	Carbide		6

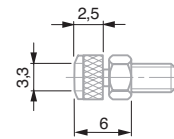

03510502

Spherical Measuring Inserts, $R 1 - 8$ mm, $L > 18$ mm

No			\varnothing , mm
03560051	Carbide		1
03560052	Carbide		2
03560053	Carbide		3
03560054	Carbide		4
03560055	Carbide		5
03560056	Carbide		6
03560057	Carbide		7
03560058	Carbide		8

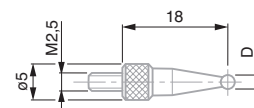

03560051 to 03560058



INSERTS FOR AXIAL PROBES, WITH M2,5 THREAD

Inserts with a Flat Measuring Face $\varnothing 1,5$ mm, Interchangeable Pin, Steel or Carbide

No	\varnothing			L, mm
03560008	1,5	Steel		20
03560009	1,5	Carbide		20

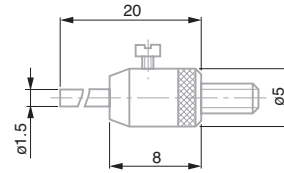

03560008, 03560009

Inserts with Flat Measuring Face, $\varnothing 2$ mm, Steel

No	\varnothing			L, mm	L1, mm
03560026	2			5	2,8
03560027	2			10	7,8
03560028	2			15	12,8
03560029	2			20	17,8

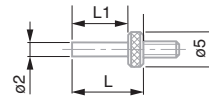

03560026 to 03560029

Insert with Offset (6,5 mm) Measuring Contact Point, Lock Nut for Radial Alignment

No			L (offset), mm
03510401	Steel		6,5

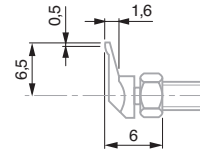

03510401

Inserts with a Flat Measuring Face, $\varnothing 2,5 - 3,4$ mm

No	\varnothing			L, mm
03510801	2,5	Steel		6
03510802	2,5	Carbide		6
03560022	3,4	Steel		8
03560023	3,4	Carbide		8

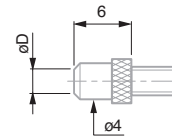

03510801, 03510802, 03560022, 03560023

Inserts with Flat Measuring Face, $\varnothing 5 - 10 - 20$ mm

No	\varnothing			L, mm
03560012	5	Steel		5
03560013	5	Carbide		5
03560014	10	Steel		6
03560015	10	Carbide		6
03560016	20	Steel		3,6

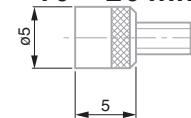

03560012, 03560013

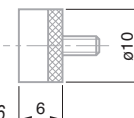

03560016

Insert with Off-centre (6,5 mm) Narrow Face, Lock Nut for Radial Alignment

No			B (measuring face contact), mm
03510602	Carbide		0,5

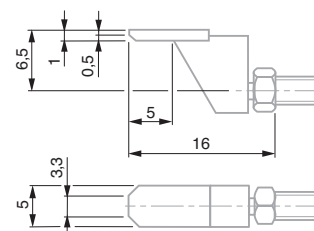

03510602



INSERTS FOR AXIAL PROBES, WITH M2,5 THREAD

Insert with a Flat Measuring Face, \varnothing 2,5 mm, Adjustable Parallelism, Counter-nut for Radial Alignment

03510902	2,5	Carbide	16

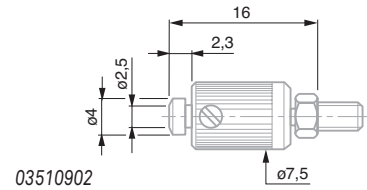

Insert with Offset (12 mm) Contact Point, Lock Nut for Radial Alignment

03560063	Steel	L (offset), mm	12

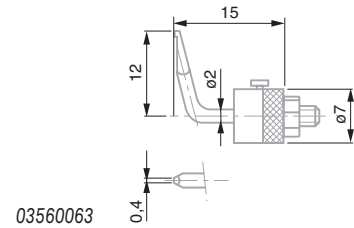

Insert with Narrow Measuring Face, Adjustable Parallelism, Counter-nut for Radial Alignment

03510702	Carbide	B, mm	0,5

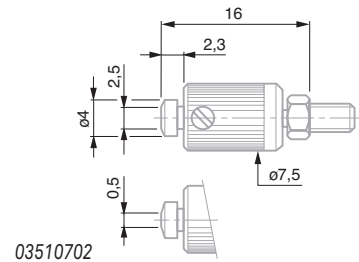

Inserts with Blade-shaped Measuring Face, Lock Nut for Radial Alignment

		L, mm	B (measuring face), mm
03560024	Steel	8	0,3
03560025	Carbide	8	0,3

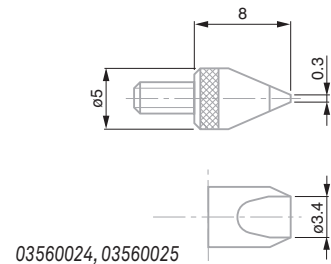

Measuring Inserts with Ball-bearing Rollers, Lock Nut for Radial Alignment

	Roller shape	L, mm	
03560010	Cylindrical	Steel	17,25
03560011	Domed	Steel	17,25

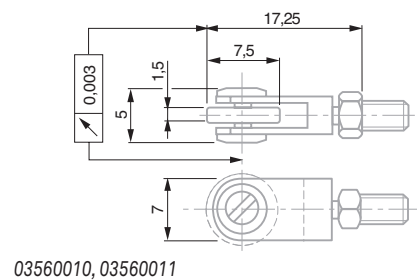

Insert with Needle Contact Point

03560030

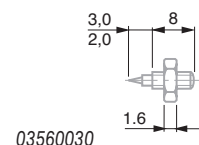

SPRING SETS, BELLOWS, CLAMPING ELEMENTS, MANUAL RETRACTION FOR AXIAL PROBES

Spring Sets for Axial Probes

No	=	Measuring force (N)
03260419	Spring sets for GT22	0,16
03260420	Spring sets for GT22	0,25
03260457	Spring sets for GT21/22	0,63
03260422	Spring sets for GT21/22	1,0
03260423	Spring sets for GT21/22	1,6
03260424	Spring sets for GT21/22	2,5



All values given in the table for the measuring force equal nominal values at electrical zero; max. deviation $\pm 25\%$. Valid for upright assembly position with downward oriented measuring bolt, and used in static measurement.



Plastic sleeve marked with force related data



Packed suitable for transport

Bellows for Axial Probes

No	=	
03260468	For 4,3 mm bolt travel GT 21, 22, GTL 21, 211, 22	Nitrile
03260470	For 4,3 mm bolt travel GT 21, 22, GTL 21, 211, 22	Viton
03260489	For pressure probe 4,3 mm bolt travel GTL 212, 222	Viton
03260491	For 10,3 mm bolt travel GT 27, 271, 28, 61, 611, 62	Viton
03260490	For pressure probe 10,3 mm bolt travel GT 272, 282, 612, 622	Viton

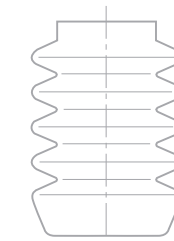

Protection bellows



Nitrile: resistant synthetic sealing for normal use. Viton: high-resistance synthetic sealing. Used in conditions where probes are permanently exposed to coolants and lubricants.



Packed suitable for transport

Clamping Elements for Axial Probes

Elements with 3 clamping faces – Prevents any deformation of the measuring bolt guiding system, thus preserving all the metrological properties of the probe.

No	=	∅	A mm
02611013	VKD clamping screw		M4
02611014	VKE clamping sleeve	∅ 8 mm	
01860401	Y61 fixing clamp	∅ 5,6 mm and ∅ 9,5 with dovetail	
02660048	VDE 28 probe holder	∅ 8 mm	



All dimensions to be noted are shown in the drawing.



Packed suitable for transport

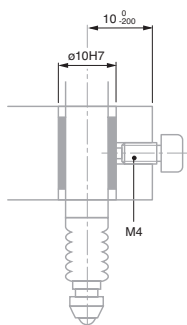

Fixing clamp for axial probe

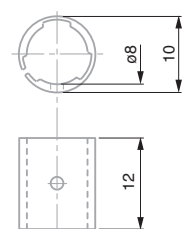

VKE – clamping sleeve

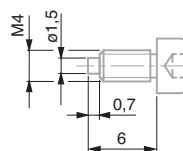

VKD – clamping screw

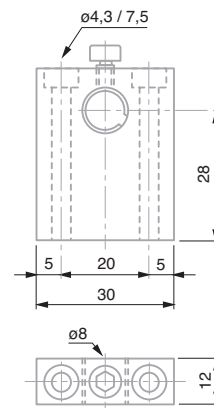

VDE – clamping élément with sleeve and clamping screw





Packed suitable for transport

Manual Measuring Bolt Retraction for Axial Probes

No	=	
03540104	TB 11 retraction device components	Consisting of: - 1 Washer TB102 (03540102) - 1 Lifting Lever TB101 (03540101)
03260401	Manual pneumatic retraction device.	Suitable for GT 22, 271, 28, 42, 44, 611, 62 – GTL211, 22 probes Consisting of: - 1 hand-operated vacuum pump - 1 tube of 1m, Ø 4,7 mm (ref. 03540405)
03540405	TB311 flexible tube	

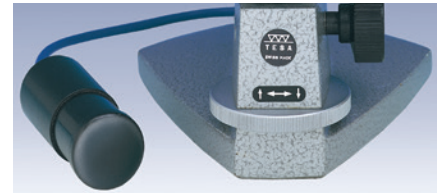

Stainless steel measuring insert, carbide ball tip

Packed suitable for transport

ACCESSORIES FOR GT 31 LEVER PROBES

Probe Inserts for GT 31 Lever Probes

No	Ø	Lever – amplification	L, mm	A
03260402	1	1:1	32	One-piece shaft
03260410	2	1:1	32	One-piece shaft
03260403	3	1:1	32	One-piece shaft
03590002	1	1:1	32	Two-piece shaft
03590003	2	1:1	32	Two-piece shaft
03590004	3	1:1	32	Two-piece shaft
03590005	4	1:1	32	Two-piece shaft

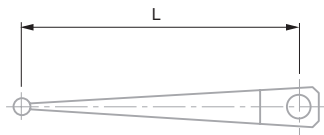

03260410



03260410



Packed suitable for transport

Fixing Bracket for TESA GT 31 Lever Probe

No	=	
03240100	Fixing bracket with dovetail clamp or cylindrical bore for GT31 probe	

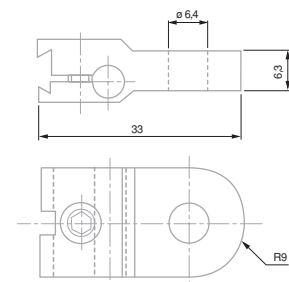

03240100



INSERTS WITH Ø 4 MM MOUNTING SHAFT, FOR FMS PROBES

Probe Inserts with a Flat Rectangular Face, Ø 4 mm Mounting Shaft for FMS Probes

No			L, mm
02660066	Carbide	12	
02660068	Carbide	25	
02660067	Carbide	12	
02660069	Carbide	25	

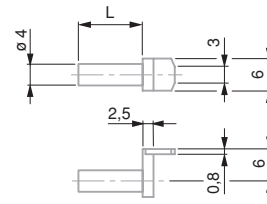

02660067, 02660069

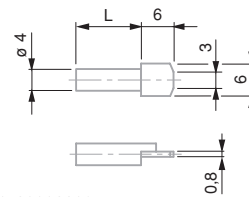

02660066, 02660068

Probe with 2 Cylindrical Measuring Faces with Ø 4 mm Mounting Shaft, for FMS Probes

No			L, mm
02660070	Carbide	20	
02660071	Carbide	40	
02660072	Carbide	60	
02660082	Carbide	40	
02660083	Carbide	60	

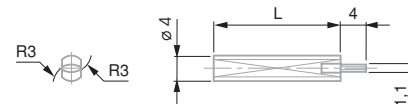

02660070, 02660071, 02660072

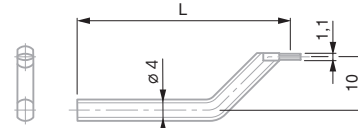

02660082, 02660083

Insert with Ø = 2 mm Diameter Contact Pin, Hemispherical Face with Ø 4 mm Diameter Mounting Shaft for FMS Probes

No			L, mm
02660074	Carbide	40	

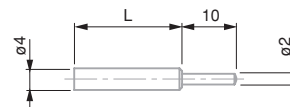

02660074

Probe with Ball Tip Ø 4 mm for FMS Probes

No			L, mm
02660076	3	Carbide	20
02660077	3	Carbide	40
02660078	3	Carbide	60
02660079	5	Carbide	20
02660080	5	Carbide	40
02660081	5	Carbide	60
02660084	5	Carbide	20
02660085	5	Carbide	33

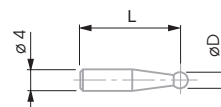

02660076 to 02660081

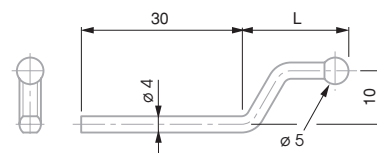

02660084, 02660085



Packed suitable for transport



Packed suitable for transport



Packed suitable for transport



Packed suitable for transport





Packed suitable for transport

INSERTS WITH Ø 6 MM MOUNTING SHAFT, FOR FMS PROBES

Inserts with Ball Tip, Ø 6 mm Mounting Shaft, for FMS Probes

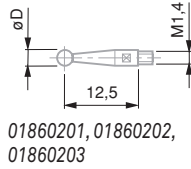

No	Ø	Material	L, mm
00760058	3	Carbide	55
00760059	5	Carbide	56
00760060	10	Carbide	55
01860201	1	Carbide	12,53
01860202	2	Carbide	12,53
01860203	3	Carbide	12,53
01860307	Wrench	-	-

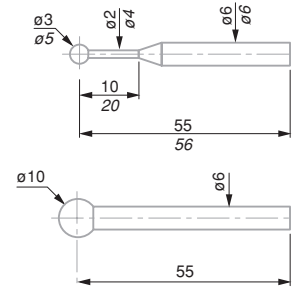

00760058, 00760059, 00760060



Packed suitable for transport

Barrel Shaped Inserts for Bores, Ø 6 mm Mounting Shaft, for FMS Probes

No	Ø	Material	Thread
00760066	2,2	Carbide	M3 to M16
00760067	4,5	Carbide	M6 to M48
00760068	9,7	Carbide	M12 to M150

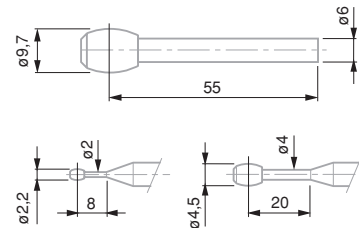

00760066, 00760067, 00760068



Packed suitable for transport

Disc Inserts for Grooves, Ø 6 mm Mounting Shaft, for FMS Probe

No	Ø	Material	Disc thickness, mm
00760074	4,5	Carbide	1
00760075	14	Carbide	2
00760076	19	Carbide	3

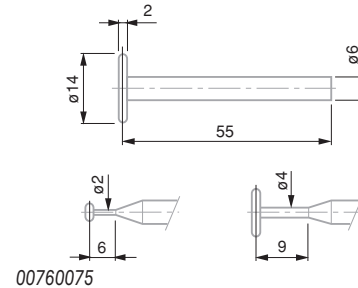

00760075

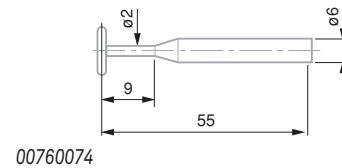

00760074



Transport packaging

Special Inserts, Ø 6 mm Mounting Shaft, for FMS Probes

No	Ø	Material	L, mm
00760082	2	Carbide	55

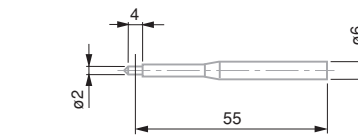

00760082



Packed suitable for transport

Universal Probe Holder with Ø 6 mm Mounting Shaft, for FMS Probes

No	Symbol	L, mm
00760096	M1,4 and M2,5 threads	55

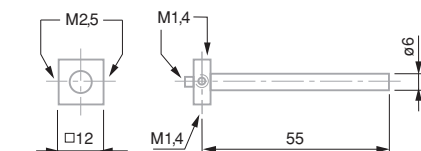

00760096



SPRINGS, PNEUMATIC ACTUATORS, HOLDERS, OFF-SET INSERTS, FOR FMS PROBE

Inserts with Offset Measuring Faces, for FMS Probes

No	=	A	Drawing
02630047	VBM offset insert	1	
02630048	VBN offset insert	2	
02630049	VBO offset insert	3	
02630050	VBP offset insert	4	
02630051	VBQ offset insert	5	

Inserts with offset faces for FMS probes

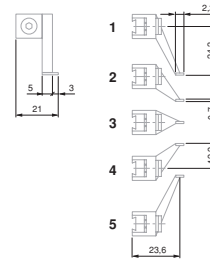

Packed suitable for transport

Fixed Holder, for FMS Probe

No	=	∅	A	A	Number	Position
02630042	VBH fixed holder	4	2	Horizontal		
02630043	VBJ fixed holder	4	1	Vertical		
02630045	VBK fixed holder	6	2	Horizontal		
02630046	VBL fixed holder	6	1	Vertical		

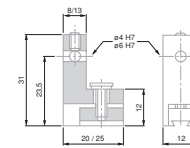

02630042
02630045

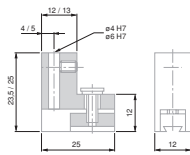

03230043
03230046



Packed suitable for transport

Holder with Fine Adjustment for FMS Probe

Helps greatly for setting a FMS probe.

Setting and locking screws remain accessible even when several probes are mounted side by side.

No	mm	∅	A	A	Number	Position
02630053	25	4	2	Horizontal		
02630055	25	4	1	Vertical		
02630052	25	6	2	Horizontal		
02630054	25	6	1	Vertical		

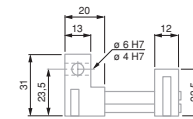

02630052
02630053

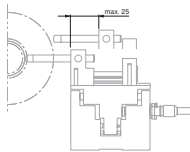

02630053



Holder width: 12 mm

Packed suitable for transport

Auxiliary Springs and Pneumatic Retraction Jack, for FMS Probe

No	=	Hand	N
03260440	Pneumatic jack	11 (for 4 bars)	
03260441	Spring element	0,4	
03260442	Spring element	0,63	
03260443	Spring element	1,0	
03260444	Spring element	1,6	
03260445	Spring element	2,0	
03260446	Spring element	2,5	
03260447	Spring element	4,0	

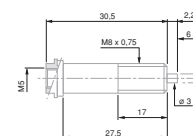

Pneumatic cylinder (jack) for FMS probe

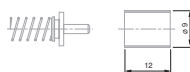

Auxiliary spring element for FMS probe



All values given in the table for the measuring force equal nominal values at electrical zero; max. deviation $\pm 25\%$. Valid for probing movements executed horizontally as well as in static measuring.

Packed suitable for transport

Spring Set with Specific Measuring Force, for FMS Probe

No	=	Hand	Measuring force, N
03260448	Spring set red	0,4	
03260449	Spring set yellow	0,63	
03260450	Spring set green	1,0	
03260451	Spring set blue	1,6	
03260452	Spring set brown	2,5	
03260453	Spring set black	4,0	

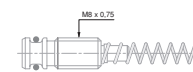

Spring set for measuring force for FMS probe



All values given in the table for the measuring force equal nominal values at electrical zero; max. deviation $\pm 25\%$. Valid for probing movements executed horizontally as well as in static measuring mode.

Packed suitable for transport



230 V 50 Hz



Packed suitable for transport

Maximum 20 probes type GT 22, GT 42 and GT 44, maximum force 0,63 N. Maximum 10 probes type GT 28 and GT 62, Maximum force 0,63 N.

(03260486) 3,5 kg

Electro-pneumatic Pump for Measuring Bolt Retraction

Electro-pneumatic vacuum pump, controlled by external switch (03260433): requires an automatic external command (e.g. instrument display).

No	=	A	
03260432	Electro-pneumatic vacuum pump with activation by connected foot switch	Electro-pneumatic vacuum pump. For the simultaneous retraction of a maximum number of 20 measuring bolts with a force up to 0,63 N	Activation by connected foot switch
03260433	Electro-pneumatic vacuum pump with activation by external control	Electro-pneumatic vacuum pump. For the simultaneous retraction of a maximum number of 20 measuring bolts with a force up to 0,63 N	Activation by external control



Electro-pneumatic vacuum pump



Packed suitable for transport

Connectors for Electro-pneumatic Pump for Measuring Bolt Retraction

No	=
03540403	T-connector for tube $\varnothing 4,7 / \varnothing 2$ mm (03540405)
03560000	Straight connector, M4 thread for tube $\varnothing 4,7 / \varnothing 2$ mm (03540405)
03560002	Angled connector, M4 thread for tube $\varnothing 4,7 / \varnothing 2$ mm (03540405)

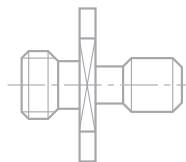

Straight connectors

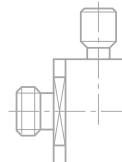

Angled connector

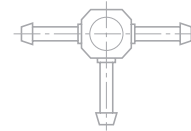

T-connector



Extension Cable for Probes, Lengths = 1 – 20m

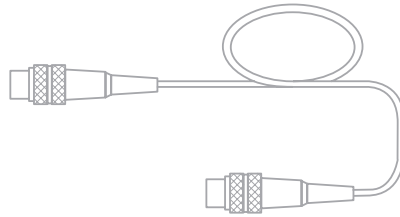

Cable extensions for TESA probes
DIN 453225, 5 pin connector

No	=	Length, m (inch)
03240201		1m (3")
03240202		2m (6")
03240203		3m (9")
03240205		5m (32")
03240210		10m (49")
03240215		15m (65")
03240220		20m (16")



L, mm



It is recommended to calibrate equipment (probe + extension) connected together to ensure the highest accuracy.



Packed suitable for transport

