

Height Gauges



INSPECTION DURING THE COURSE OF THE MANUFACTURING PROCESS

Height gauges are single-axis handtools made to measure on a surface plate, preferably on granite. The TESA- μ HITE version being offered in this section clearly shows that combining a surface plate with any height gauge can create a complete measuring system.

Providing the necessary versatility, they are well suited for dimensional inspection directly on a machine or a group of machines, usually during the various setting and sampling operations throughout the whole manufacturing process.

They are specially made for checking parts that are difficult to machine due to their critical sizes.

TESA-HITE or TESA MICRO-HITE, whether manually operated or motor-driven, do not require any special skills. Nearly everyone working in the workshop can use them easily.



SCS Calibration Certificate

The newly implemented TESA-HITE and TESA MICRO-HITE production line now also includes its own temperature-controlled laboratory recently certified by the Swiss Accreditation Service (SCS), so that each height gauge comes with a SCS calibration certificate provided free of charge.

The negligible temperature variation ($20^{\circ}\text{C} \pm 0,1^{\circ}$) along with the use of high-precision step gauges allow the lowest uncertainty of measurement to be achieved during the calibration process.

As a first step, all values needed for automatic compensation for the systematic errors of the finished height gauge through Computer Aided Accuracy (CAA) are captured.

Once conveniently calculated, each single compensation value is then stored in the tool memory so as to allow the automatic calculation of the measured values during calibration.

Finally, the relevant calibration certificate is issued based on the values obtained during a new series of measurements taken at another measuring station, also equipped with step gauges. The applied calibration procedure together with the SCS based certification ensure that every TESA height gauge is traceable to national standards.

Height Gauges – One of TESA's Strengths

TESA offers the largest range of height gauges for reliable one or two-dimensional measurements. End users can choose the most suitable model not only according to the requirements of their metrology applications, but also according to their financial resources.

This wide range goes from the simple height and scribing gauge to the motorised vertical column suitable for high-precision measurements in two coordinate directions.



				1D				2D		Motorized
Height Gauges	µm (L in m)	Standard Accessory (mm)	Special Accessory (mm)							
TESA-HITE Magna	8	870	1095	•	•					
TESA-HITE	2,5 + 4L	870	1095	•	•	•				
TESA-HITE plus M	2,5 + 3L	860	1085	•	•	•	•	•	•	•
TESA MICRO-HITE	2 + 3L	1075	1300	•	•	•	•	•		
TESA MICRO-HITE plus M	1,9 + 1,5L	1075	1300	•	•	•	•	•	•	•
TESA-µHITE	1 or 2	160	360	•	•					•
TESA-µHITE + POWER PANEL plus M	1 or 2	160	360	•	•		•	•	•	•
ETALON height and scribing gauges	40	1000	-	•						



TESA-HITE Magna 400 and 700

Conceived using well-proven TESA technology, both the TESA-HITE magna 400 and 700 models are equipped with the TESA patented magna μ measuring system and can be used in the harshest workshop conditions, especially where the gauges are exposed to splashing liquids of any kind and the penetration of dust particles. Their unique characteristics means that the gauges offer the most favourable price/performance ratio found in the market and constitute an essential tool in the workshop. Robust and reliable, their futuristic design guarantees maximum strength when used near production machines. Each height gauge is provided with a rechargeable battery and can be used to measure height or step dimensions as well as diameters, centre to centre distance of bores or grooves, the size of grooves and much more.

- Wide application range, two sizes available with measuring span to 415 mm/ 16 in or 715 mm/28 in, respectively.
- Electronics totally protected against oil and water splashing or dust particles (IP65).
- Control panel with numerical display to 0,001 / 0,005/0,01 mm or 0,0001/0.0002/ 0.001 in.
- Dynamic probing of the workpiece with a constant measuring force.
- Easiness, high reliability when checking bores or shafts using TESA's unique device for automatic detection of the culmination point – patented.
- Acoustic signal to acknowledge value capture, also conveniently program-mable.
- Ability to measure parallelism errors.
- TESA's magnetic system, guaranteeing correct operating even in harsh workshop conditions – patented.
- Large LC display, also with symbols for the measuring functions.
- Zero-setting anywhere within the measuring range.
- PRESET function for entering any given value.
- Metric/inch conversion.
- RS 232 data output.
- SCS calibration certificate provided with each height gauge.

- Factory standard
- 83 x 49 mm LC display, 7-decade plus minus sign. Also with graphical symbols for all active functions.
- 0,001 / 0,005 / 0,01 mm or 0,0001 / 0.0002 / 0.001 in
- 12 mm
- Magnetic scale
- Metric/Inch conversion
- Nickel plated gauge base (chemical coating)
- 1,5 \pm 0,5 N (at switch point)
- 500 mm/s 20 in/s
- Measuring span, application range and precision: see relevant table on page N-5.
- Probing head mounted on a ball-bearing, hand wheel for head displacement, fine setting. Head drive carriage can be locked.
- RS232
- Rechargeable batteries, 6V
- ~ 60 h



- $(12 \pm 1,5) \times 10^{-6} K^{-1}$
- 10°C to 40°C
- 10°C to 60°C
- 100 %
- IP55 or IP65 for both electronics and measuring system (IEC 60529)
- EN 61326, Class B (with disconnected charger)
- See table
- Shipping packaging
- Identification number
- Declaration of conformity
- SCS calibration certificate

No	=		
		mm	in
00730047	Height gauge TESA-HITE magna 400	415	16
00730059	Height gauge TESA-HITE magna 700	715	28
CONSISTING OF:		400	700
00760143	Standard probe insert holder	●	●
00760157	Rechargeable battery, 6V	●	●
00760164	Standard probe insert with 5mm dia. tungsten carbide ball tip	●	●
00760231	Master piece for establishing the probe constant, nominal dimension 6,350 mm / 0.250 in	●	●
04761054	Mains adapter 100 ÷ 200 VAC / 50 ÷ 60 Hz	●	●
04761055	Cable EU for mains adapter	●	●
04761056	Cable US for mains adapter	●	●
OPTIONAL ACCESSORIES:			
04761052	Extension cable, Sub-D 9p/f to 9p/m, 2 m		
04761063	Sub-D 9p/m to USB cable, 2 m		

Technical Data

	Models	TESA-HITE magna	TESA-HITE magna
		400	700
		mm	mm
		in	in
	With standard accessory	mm	mm
		in	in
	With probe insert holder No. 00760057	mm	mm
		in	in
	With probe insert holder No. S07001622	mm	mm
		in	in
	With standard accessory	µm	µm
		in	in
	With standard accessory	On flat surfaces: 2σ < 3µm / < 0.00015 in	
		Into bores: 2σ < 5µm / < 0.00020 in	
		kg	kg

Standard Accessories

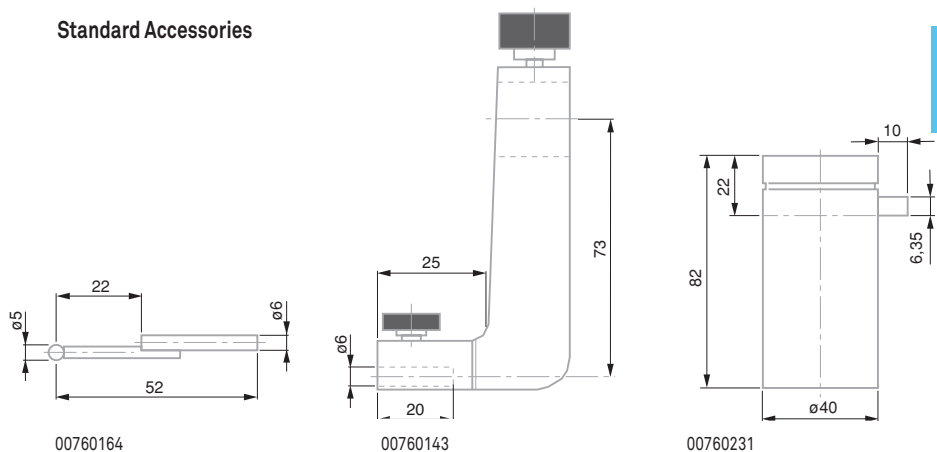

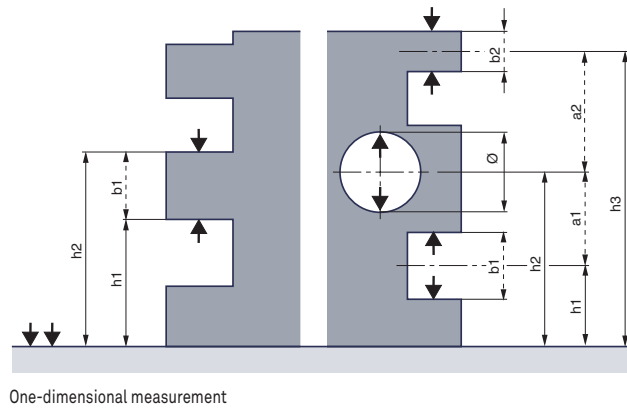
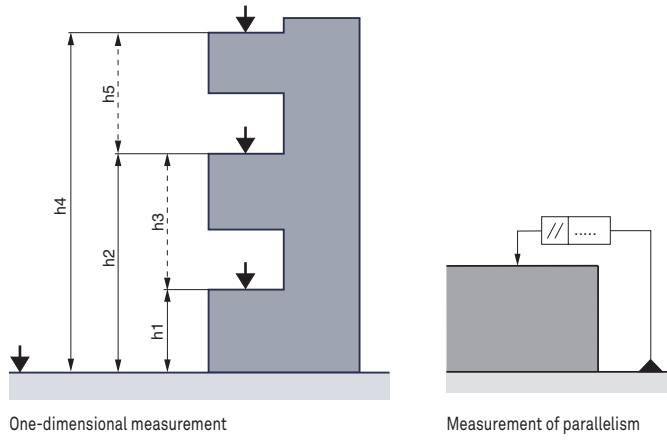



N Factory standard

000 83 x 49 mm LC display. 7-decade plus minus sign. Also with graphical symbols for all active functions.

000 0,0001 / 0,001 / 0,01 mm or 0,00001 / 0,0001 / 0,001 in

B 12 mm

III Incremental glass scale, opto-electronic

mm/in mm/in conversion

I Frontal, model 400 <math>< 9 \mu\text{m}</math>, model 700 <math>< 13 \mu\text{m}</math>

NI Nickel plated gauge base (chemical coating) with bottom face including 3 resting points, finely lapped.

H 1,5 ± 0,5 N (at switch point)

C 500 mm/s 20 in/s

A Air-cushion for easy displacement over the surface plate. Measuring span, application range and precision: see table on page N-8.

NI Probing head mounted on a ball-bearing, hand wheel for head displacement, fine setting. Head drive carriage can be locked.

RS232

B Rechargeable batteries, 6V

B ≈ 60 h

TESA-HITE 400 / 700

By their robustness and reliability, the TESA-HITE 400 and 700 provided with its optoelectronic incremental rule (TESA patented) measurement system are ideally suited for applications in the workshop.

Their battery power gives them full autonomy.

Each version allows, among other things, the entry height dimensions or staged, the diameter, the distance between two grooves or two holes and groove width.

- Integrated air-bearing for easy displacement across the granite plate.
- Electronics totally protected against oil and water splashing, dust particles (IP65).
- Control panel with numerical display to 0,0001 / 0,001 / 0,01 mm or 0.00001 / 0.0001 / 0.001 in.
- Dynamic probing of the workpiece with a constant measuring force.
- Easiness, high reliability when checking bores or shafts using TESA's unique device for automatic detection of the culmination point – patented.
- Acoustic signal to acknowledge value capture, also conveniently programmable.
- Ability to measure any deviation in parallelism.
- Possible use of a digital sensor for determining perpendicularity errors with stated angle of the linear regression line.
- Patented TESA's opto-electronic system. Long-lasting stability of the glass scale for unbroken high accuracy.
- Large LC display with symbols for the measuring functions.
- Zero-setting anywhere within the measuring range.
- PRESET function for entering any given value.
- Metric/inch conversion.
- RS 232 data output.
- SCS calibration certificate provided with each height gauge.



No	=		
		mm	in
00730043	TESA-HITE 400	415	16
00730044	TESA-HITE 700	715	28
CONSISTING OF:		400	700
00760143	Standard probe insert holder	●	●
00760157	Rechargeable battery, 6V	●	●
00760219	Master piece for establishin the probe constant, nominal dimension to 6,350 mm / 0.250 in	●	●
00760226	Electric pump for creating the air-cushion beneath the gauge base, already mounted	●	●
00760227	Standard probe insert with shank and 5 mm dia. ball tip in tungsten carbide	●	●
04761054	Mains adapter 100 ÷ 200 VAC / 50 ÷ 60 Hz	●	●
04761055	Cable EU for mains adapter	●	●
04761056	Cable US for mains adapter	●	●
OPTIONAL ACCESSORIES:			
04761052	Extension cable, Sub-D 9p/f to 9p/m, 2 m		
04761063	Sub-D 9p/m to USB cable, 2 m		
04760070	RS port, used to connect a digital sensor for perpendicularity measurement		

- $(12 \pm 1,5) \times 10^{-6} K^{-1}$
- 10 °C to 40 °C
- 10 °C to 60 °C
- 80 %, non-condensing
- IP40, electronics to IP65 (IEC 60529)
- EN 61326, Class B (with disconnected charger)
- See table opposite
- Shipping packaging
- Identification number
- Declaration of conformity
- SCS calibration certificate

Technical data

=	Models	TESA-HITE 400		TESA-HITE 700	
		mm	in	mm	in
		415	16	715	28
	With standard accessory	mm	0 ÷ 570	mm	0 ÷ 870
		in	0 ÷ 22	in	0 ÷ 34
	With probe insert holder No. 00760057	mm	0 ÷ 625	mm	0 ÷ 925
		in	0 ÷ 24	in	0 ÷ 36
	With probe insert holder No. S07001622	mm	0 ÷ 795	mm	0 ÷ 1095
		in	0 ÷ 31	in	0 ÷ 43
	With standard accessory	µm	(2,5 + 4 L) µm (L in m)		
		in	(0.0001 + 0.000004 L) in (L in in)		
	With standard accessory	On flat surfaces:			
		$2\sigma < 2 \mu\text{m} / < 0.0001 \text{ in}$			
		Into bores:			
	Frontal, mechanical	µm	9	µm	13
		in	0.00035	in	0.0005
		kg	27	kg	32

Standard Accessories

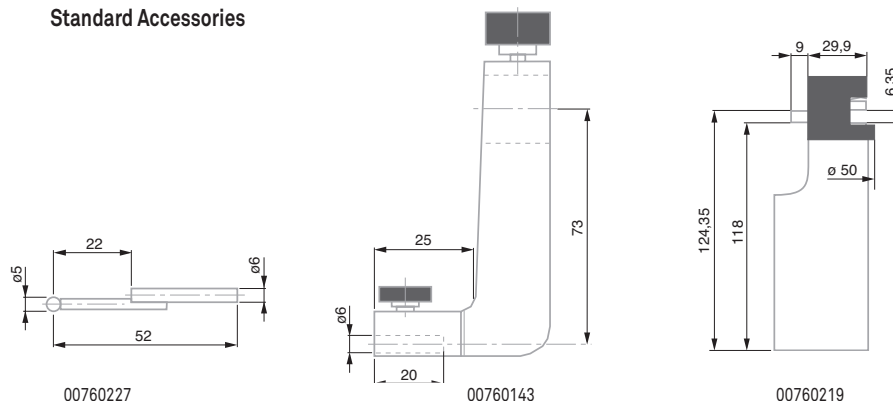

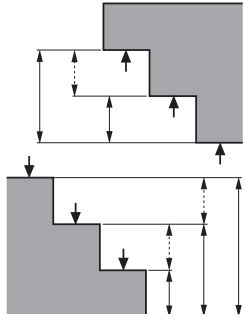

One-dimensional measurement

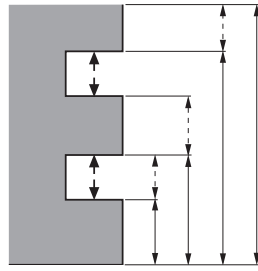

One-dimensional measurement

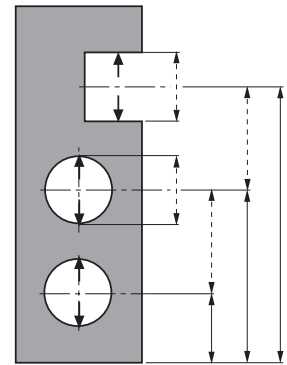

One-dimensional measurement

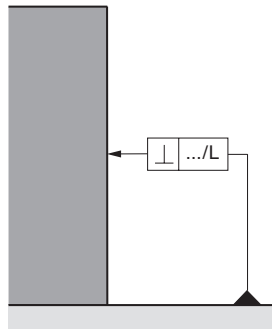

Perpendicularity measurement

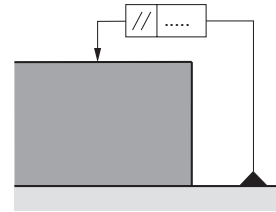

Parallelism measurement

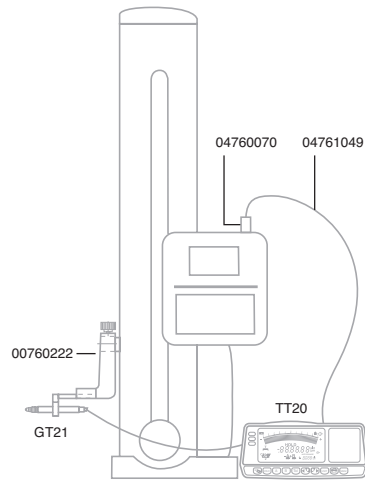

Configuration for perpendicularity measurement

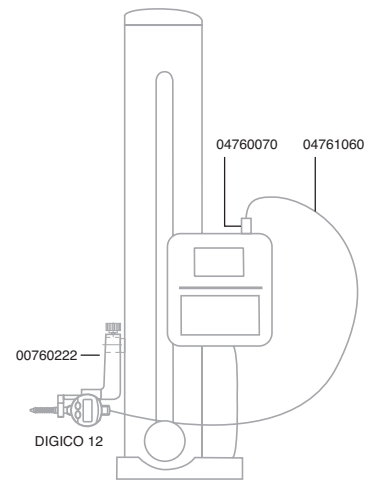

Configuration for parallelism measurement



TESA-HITE Plus M 400 / 700

The added value of the motorised TESA-HITE plus M 400 / 700 is not only noticeable in their technical features, but also in their ease of use. Combine with the programming function, this solution is ideal for recurrent measurements in the shop floor environment.

Advanced functions allow for complex calculations such as those required for two-axis or perpendicularity measurement. These height gauges with outstanding features offer the most attractive price/performance relationship, making them indispensable for the workshop.

- Wide application range.
- Electronics entirely protected from the penetration of liquids and dust particles.
- Integrated air cushion, mounted control panel.
- Easy, intuitive use of the rotary power control.
- Provide all the measuring functions of a dedicated motorised column, including height, diameter, distance, parallelism, perpendicularity, straightness, angle and 2D measurement besides programming, automatic probing cycles, statistical value processing.
- TESA's patented measuring system, opto-electronic.
- Probe insert holder and inserts compatible with those of TESA MICRO-HITE.
- SCS calibration certificate attached to each height gauge.



- Factory standard
- Dual LC display, 128 x 63 mm in size.
- Dual LC display, 128 x 63 mm in size.
 - Upper display field for length values (7 segments/sign) also with symbols for the functions.
 - Lower full dot display field for perpendicularity and straightness along with symbols for all operator-controlled function keys.
 - 7 segment display plus minus sign for the measured values
- 0,0001 / 0,001 / 0,01 mm or 0.00001 / 0.0001 / 0.001 in
- Incremental glass scale, opto-electronic data capture
- Main display with a size to 12,7 x 6,4 mm or 6,3 x 4,2 mm for auxiliary display
- Frontal for models 400 = < 8 µm 700 = < 12 µm
- Rugged nickel plated gauge base having 3 resting points, finely lapped.
- 1 N. Coupled servomotor for triggering the measuring force.
- Air bearing for easy displacement on the granite plate. For measuring span, application range and precision: see the table on page N-11. 30 function keys available on the keyboard.
- Measuring head mounted on a ball-bearing. Electro-motorised head displacement at varying speeds from 7,5 up to 40 mm/s. Manual displacement: ≤ 600 mm/s. Automatic value acquisition with a constant measuring force.
- RS232
- Rechargeable batteries, 6V
- ≈ 60 h, full charging takes 8 hours



- $(12 \pm 1,5) \times 10^{-6} K^{-1}$
- 10 °C to 40 °C
- 10 °C to 60 °C
- 80 %, non-condensing
- IP40, IP65 for the electronic control panel (IEC 60529)
- EN 61326, class B (with disconnected battery charger)
- See table opposite
- Shipping packaging
- Identification number
- Declaration of conformity
- SCS calibration certificate

No			
00730045	TESA-HITE plus M 400	405	16
00730046	TESA-HITE plus M 700	705	27
00730057	TESA-HITE plus M 400 + printer	405	16
00730058	TESA-HITE plus M 700 + printer	705	27
CONSISTING OF:		400	700
00760143	Standard probe insert holder	●	●
00760157	Rechargeable battery, 6V	●	●
00760219	Master piece for establishin the probe constant, nominal dimension to 6,350 mm / 0.250 in	●	●
00760226	Electric pump for creating the air-cushion beneath the gauge base, already mounted	●	●
00760227	Standard probe insert with shank and 5 mm dia. ball tip in tungsten carbide	●	●
04761054	Mains adapter 100 ÷ 200 VAC / 50 ÷ 60 Hz	●	●
04761055	Cable EU for mains adapter	●	●
04761056	Cable US for mains adapter	●	●
OPTIONAL ACCESSORIES:			
04760070	RS port, used to connect a digital sensor for perpendicularity measurement		
04761052	Extension cable, Sub-D 9p/f to 9p/m, 2 m		
04761063	Sub-D 9p/m to USB cable, 2 m		
04765008	Thermal paper 57 MM		

Technical Data

	Models		TESA-HITE plus M 400	TESA-HITE plus M 700
		mm	405	705
		in	16	27
	With standard accessory	mm	0 ÷ 560	0 ÷ 860
		in	0 ÷ 22	0 ÷ 33
	With probe insert holder No. 00760057	mm	0 ÷ 615	0 ÷ 915
		in	0 ÷ 24	0 ÷ 35
	With probe insert holder No. S07001622	mm	0 ÷ 785	0 ÷ 1085
		in	0 ÷ 31	0 ÷ 42
	With standard accessory	µm	(2,5 + 3 L) µm (L in m)	
		in	(0.0001 + 0.000003 L) in (L in in)	
	With standard accessory		On flat surfaces: 2 σ = < 1 µm / < 0.00005 in	
			Into bores: 2 σ = < 2 µm / < 0.0001 in	
	Frontal, mecanical	µm	8	12
		in	0.00031	0.00047
		kg	27	32

Standard Accessories

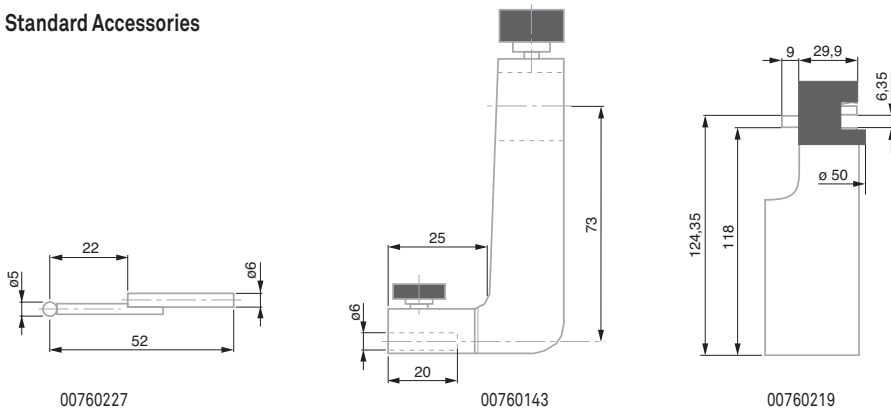

TESA MICRO-HITE 350 / 600 / 900

Autonomous instruments for measurement in one or two coordinate directions of inside dimensions, outside, step, height, depth and distance on geometric elements with flat, parallel or cylindrical surfaces.

The culmination point is automatically entered on the bores and shafts - With memory function "max.", "min." and "max.-min." as dynamic measurement. The use of digital probe TESA IG-13 can also capture perpendicularity, rectitude and parallelism differences, as well as errors of radial and axial runout. Operating results in accordance with ISO 1101.



TESA IG-13

- State-of-the-art concept associated with a high-quality design is the fruit of years of experience in the manufacture of electronic height gauges.
- Ideal for dimensional inspection close to the manufacturing cell. No cumbersome cables to clutter up the working area.
- Fast, simple and reliable probing of the workpiece or holes, especially.
- 3 main gauges available with either a 365, 615 or 920 mm measuring span.
- Numerical display to 0,0005, 0,001, 0,01 and 0,1 mm, or equivalent inch units.
- Extremely accurate measuring of deviations from length, straightness and perpendicularity due to the automatic correction of the bias errors through CAA (Computer Aided Accuracy).
- Coefficient of linear expansion identical to steel ($11,5 \times 10^{-6} \text{ K}^{-1}$).
- POWER PANEL for value processing and output with interactive display to guide the operator.
- No manual calculation.
- 99 workpiece oriented measurement cycles, programmable. Each cycle includes a number of 64 features with related limits of size.
- Built-in printer for result output or possible use of an external printer unit to get a hard copy in A4 format.
- RS232 data output.
- Every height gauge comes with a SCS calibration certificate.

TESA MICRO-HITE – Power and performance



- Factory standard
- Incremental glass scale with reference point, dividing period of 20 μm . Opto-electronic value capture (TESA patent).
- Frontal, model 350 < 7 μm , model 600 < 9 μm , model 900 < 11 μm
- Rugged nickel plated base with bottom face including 3 resting points finely lapped
- 1,6 \pm 0,25 N (at switch point for value capture)
- 300 mm/s 12 in/s
- Air cushion usable for easy move of the height gauge over the surface plate.
- Measuring span, application range and accuracy as stated in technical data table
- RS232, opto-electronic
- Rechargeable batteries, 6 V, 3,0 Ah or mains adapter
- \approx 12 hours for one battery pack; \approx 2 hours for the pump used to form the air cushion
- $11,5 \times 10^{-6} \text{ K}^{-1}$
- 10°C to 40°C
- 10°C to 60°C
- 80 % non-condensing
- IP40 (IEC 60529)
- EN 61326-1, Class B (with disconnected charger)
- Net weight (w/o panel nor battery pack) Main gauges 350: 33 kg 600: 38 kg 900: 45 kg
- Shipping packaging
- Identification number
- SCS calibration certificate



No	=			
		mm	in	
00730033	SET MICRO-HITE 350	365	14	
00730034	SET MICRO-HITE 600	615	24	
00730035	SET MICRO-HITE 900	920	36	
CONSISTING OF:		350	600	900
00730021	TESA MICRO-HITE 350 main gauge	●		
00730022	TESA MICRO-HITE 600 main gauge		●	
00730023	TESA MICRO-HITE 900 main gauge			●
00760141	Rechargeable battery pack	●	●	●
00760142	Electric pump for creating the air-cushion beneath the gauge base, already mounted	●	●	●
00760143	Standard probe insert holder	●	●	●
00760150	Master piece for establishing the probe constant, nominal dimension to 20,000 mm / 0.78740 in	●	●	●
00760151	Dust cover for TESA MICRO-HITE 350	●		
00760152	Dust cover for TESA MICRO-HITE 600		●	
00760153	Dust cover for TESA MICRO-HITE 900			●
00760227	Standard probe insert with shank and 5 mm dia. ball tip in tungsten carbide	●	●	●
04761054	Mains adapter 100 ÷ 200 VAC / 50 ÷ 60 Hz	●	●	●
04761055	Cable EU for mains adapter	●	●	●
OPTIONAL ACCESSORIES:				
00760144	Add-on fine adjust device for extra fine movement of the measuring head, complete			
00760157	Rechargeable battery, 6V			
04761023	Cable: miniDIN 8p/m to Sub-D 9p/f, 2m for TT10 and MICRO-HITE manual versions 10/11/12			
04761056	Cable US for mains adapter			

Technical Data

Models		MICRO-HITE	MICRO-HITE	MICRO-HITE
		350	600	900
	mm	365	615	920
	in	14	24	36
With standard accessory	mm	0 ÷ 520	0 ÷ 770	0 ÷ 1075
	in	0 ÷ 20	0 ÷ 30	0 ÷ 42
With probe holder No. 00760057	mm	0 ÷ 575	0 ÷ 825	0 ÷ 1130
	in	0 ÷ 22	0 ÷ 32	0 ÷ 44
With probe holder No. S07001622	mm	0 ÷ 745	0 ÷ 995	0 ÷ 1300
	in	0 ÷ 29	0 ÷ 39	0 ÷ 51
With standard accessory	(2 + 3 L) μm (L in m) (0.0001 + 0.000003 L) in (L in in)			
	2 σ = ≤ 1 μm / ≤ 0.00005 in			
Frontal, mechanical	μm	7	9	11
	in	0.00028	0.00035	0.00043
Frontal and lateral with TESA IG-13 probe	μm	6	8	10
	in	0.00024	0.00031	0.00039

Standard Accessories

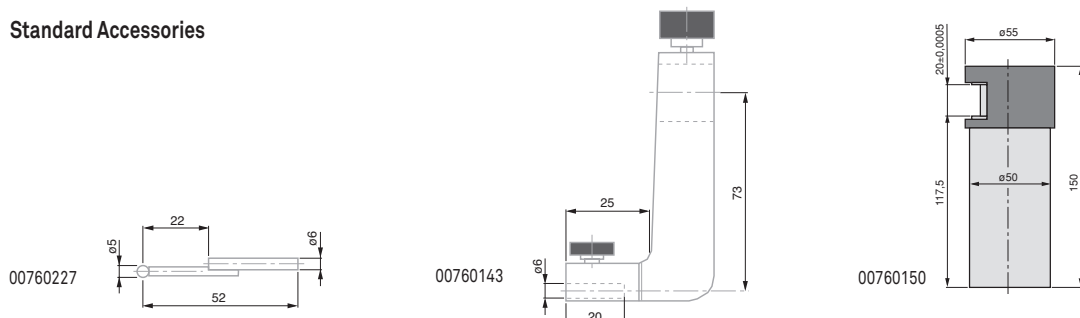

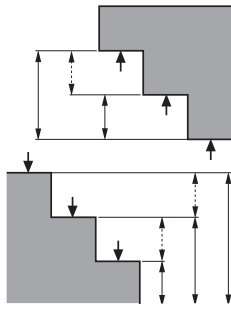

One-dimensional measurement

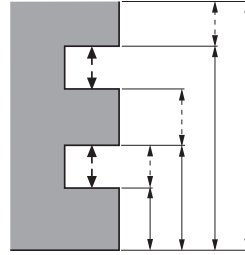

One-dimensional measurement

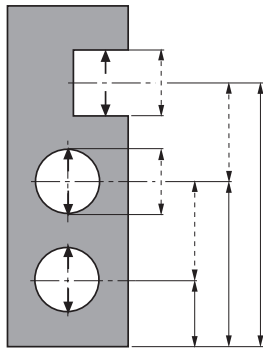

One-dimensional measurement

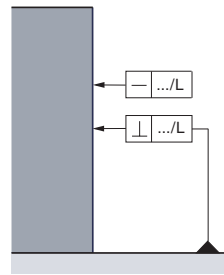

Programme functions for the detection of form and position errors.
With use of a TESA IG-13 digital probe.

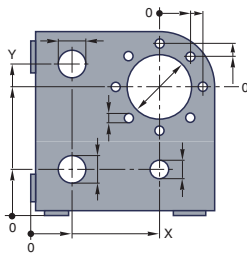

Two-Dimensional Measurement

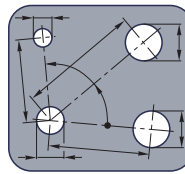

Two-Dimensional Measurement

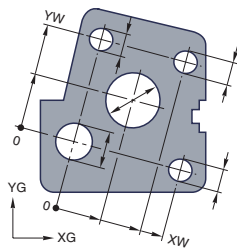

Two-Dimensional Measurement

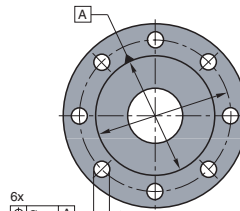

Two-Dimensional Measurement



Control Panel for TESA MICRO-HITE 350 / 600 / 900



See below

Main Display 12,7 x 6,4 mm, 6,3 x secondary display 4,2 mm.

Floating zero

Conversion mm/in

Through TESA MICRO-HITE

IP40 (CEI 60529)



Dual LCD display size 128 x 63 mm.

- Measurement of lengths value display (7 segments / sign) and function symbols (top).
- Measurement of squareness / rectitude display values and symbols (function keys, control by the operator display (points))
- Measured: 7 decades Reduce sign.

PRESET function for entering a given value. Continuous displaying. Manual or automatic triggering of data transfer. Output of pre-defined report with headers in 5 languages plus A4 format using an external printer unit.

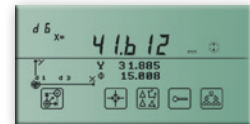

No	=	mm	in
00760163	Power Panel	0,0005 / 0,001 / 0,01 / 0,1	0,00002 / 0,0001 / 0,001 / 0,01 / 0,1
OPTIONAL ACCESSORY:			
04765008	Thermal paper, 57 mm wide		





TESA MICRO-HITE Plus M 350 / 600 / 900

All TESA MICRO-HITE plus M height gauges are unique in that they have exceptional metrological capabilities and can be used intuitively with ease.

This method allows form and position error to be easily and quickly detected by means of a lever-type dial indicator – Check deviations from straightness or parallelism according to ISO 1101 when used in conjunction with TESA IG-13 linked to the Power panel plus M.

- Modular design descending from the successful TESA MICRO-HITE dynasty.
- Also equipped with the unique rotary power control located close to the rugged base. This feature serves for guiding the column that moves on an air cushion, commanding fast motion of the probe insert and triggering all main measuring functions. Its intuitive use allows accurate, easy handling of the column. A simple rotation causes the measuring head to move rapidly, approach the contact point quickly or slowly, probe up- or downward or execute bore measurement.
- Available in three different sizes with a measuring span of 365, 615 or 920 mm.
- Choice between two control panels for value processing and output.
- Metric and inch LC display with a resolution to 0,0001 and 0,001 mm, or inch equivalent.
- Autonomous run through batteries. No cumbersome cable.
- Built-in air bearing for easy displacement over the surface plate.
- Motorised measuring head for fast, accurate probing at each contact point with a constant measuring force.
- TESA μ system for matchless reliability and simplicity.
- High precision through CAA (Computer Aided Accuracy). All correction values stored in the memory still add to the mechanical precision.
- Coefficient of linear expansion matching that of steel ($11,5 \times 10^{-6} \text{ K}^{-1}$).
- RS232 data output.
- SCS calibration certificate delivered with every height gauge.



Factory standard



Incremental glass scale with opto-electronic data acquisition. Grating period: 20 μm . Opto-electronic input (TESA Patent)



Frontal, for model 350 < 5 μm , 600 < 7 μm , 900 < 9 μm .



Rugged nickel plated gauge base having 3 resting points, finely lapped



1 N Coupled for triggering the measuring force



Built-in air-bearing for easy move of the column over the surface plate



Measuring head mounted on a ball-bearing. Motorised head displacement at a varying speed from 7,5 up to 40 mm/s. Manual displacement: $\leq 600 \text{ mm/s}$. Automatic value capture with a constant measuring force.



Field measurement application range and accuracy: see technical data table



Rechargeable 6 V, 3.0 Ah or network adapter 100 ÷ 240 Vac/50 ÷ 60 Hz



$\approx 12 \text{ h}$ after 8 h of charging



TESA μ System



Perpendicularity using TESA IG-13



Perpendicularity using TESATAST

TESA MICRO-HITE plus M

Unrivalled Power, Performances, Ease of use



- 11,5 x 10⁻⁶ K⁻¹
- 10 °C to 40 °C
- 10 °C to 60 °C
- 80 %, no condensation
- IP40 (CEI 60529)
- EN 61326-1, Class B (offline charging)
- Net weight without desks or block batteries. Basic instrument 350: 33 kg, 600: 38 kg, 900: 45 kg
- Shipping packaging
- ID Number
- Declaration of conformity
- Calibration certificate SCS

No	=			
00730063	Set MICRO-HITE plus M 350	365	14	
00730064	Set MICRO-HITE plus M 600	615	24	
00730065	Set MICRO-HITE plus M 900	920	36	
CONSISTING OF:		350	600	900
00730060	TESA MICRO-HITE plus M 350 main gauge	●		
00730061	TESA MICRO-HITE plus M 600 main gauge		●	
00730062	TESA MICRO-HITE plus M 900 main gauge			●
00760141	Rechargeable battery pack	●	●	●
00760142	Electric pump for creating the air-cushion beneath the gauge base, already mounted	●	●	●
00760143	Standard probe insert holder	●	●	●
00760219	Master piece for establishing the probe constant, nominal dimension to 6,350 mm / 0.250 in	●	●	●
00760151	Dust cover for TESA MICRO-HITE 350	●		
00760152	Dust cover for TESA MICRO-HITE 600		●	
00760153	Dust cover for TESA MICRO-HITE 900			●
00760227	Standard probe insert with shank and 5 mm dia. ball tip in tungsten carbide	●	●	●
04761054	Mains adapter 100 ÷ 200 VAC / 50 ÷ 60 Hz	●	●	●
04761055	Cable EU for mains adapter	●	●	●
04761056	Cable US for mains adapter	●	●	●
OPTIONAL ACCESSORY:				
00760157	Rechargeable battery, 6V			

Technical data

	Models		MICRO-HITE plus M 350	MICRO-HITE plus M 600	MICRO-HITE plus M 900
		mm	365	615	920
		in	14	24	36
	With standard accessory	mm	0 ÷ 520	0 ÷ 770	0 ÷ 1075
		in	0 ÷ 20	0 ÷ 30	0 ÷ 42
	With probe insert holder No. 00760057	mm	0 ÷ 575	0 ÷ 825	0 ÷ 1130
		in	0 ÷ 22	0 ÷ 32	0 ÷ 44
	With probe insert holder No. S07001622	mm	0 ÷ 745	0 ÷ 995	0 ÷ 1300
		in	0 ÷ 29	0 ÷ 39	0 ÷ 51
	With standard accessory		(1,9 + 1,5 L) µm (L in m) (0.0001 + 0.0000015 L) in (L in in)		
	With standard accessory		On flat surfaces: 2σ ≤ 0,5 µm / ≤ 0.000025 in Into bores: 2σ ≤ 1 µm / ≤ 0.00005 in		
	Frontal, mechanical	µm	5	7	9
	Frontal and lateral using TESA IG-13	in	0,00020	0,00028	0,00035

Standard Accessories

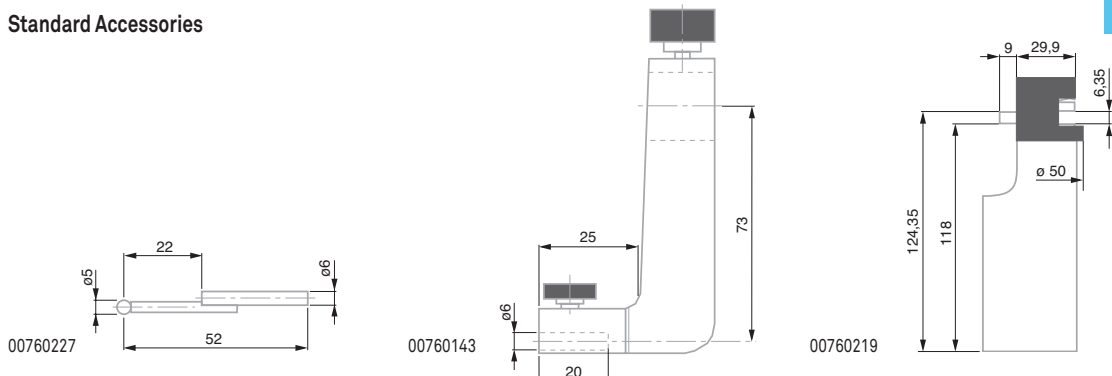

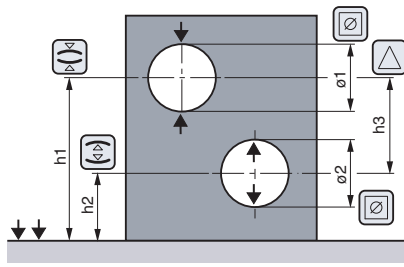

Measurement with change of the probe direction
Probe constant included, considering the culmination point

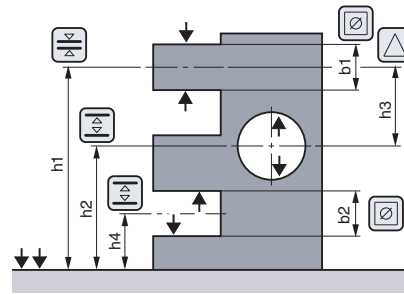

Measurement with change of the probe direction
Probe constant included, disregarding the culmination point

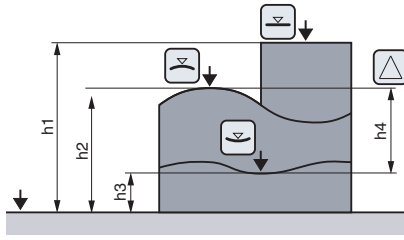

Measurement without change of the probe direction
Probe constant excluded

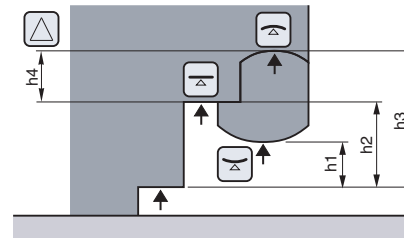

Measurement without change of the probe direction
Probe constant excluded

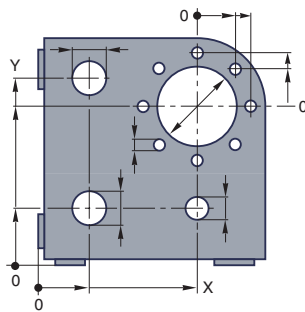

Two-Dimensional Measurement

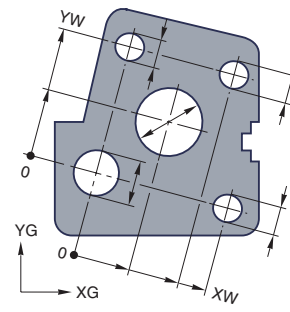

Two-Dimensional Measurement

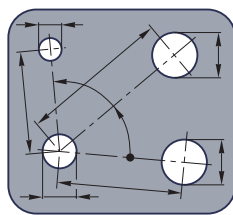

Two-Dimensional Measurement

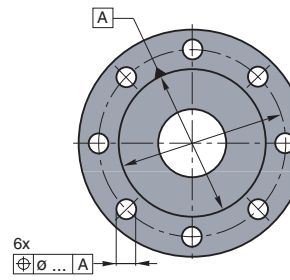

Two-Dimensional Measurement

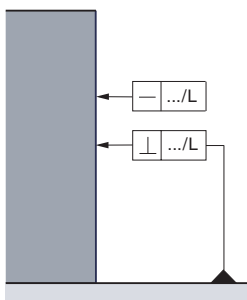

Measurement of form and position errors

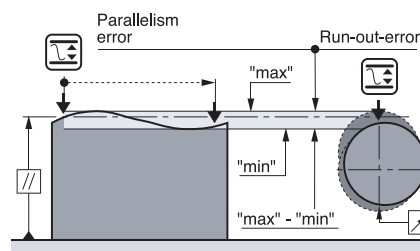

Measurement of form and position errors



Control Panels for TESA MICRO-HITE Plus M 350 / 600 / 900



See opposite



12,7 x 6,4 mm main display, 6,3 x 4,2 or 3,8 x 2,9 mm auxiliary display



mm/in conversion



Via TESA MICRO-HITE plus M



IP50 (IEC 60529)



Declaration of conformity



Keypad with 42 softkeys



Bidirectional RS232, optoelectronic and Centronics



LC dual display, 128 x 63 mm in size.

- Length measurement: 7-segment/digit upper display field for values plus symbols for the functions.
- Straightness or perpendicularity measurement: display field for values plus symbols (function keys). Operator controlled operations (full dot display).
- Measured values: 7-decade display plus minus sign.



PRESET function for entering a given value. Acoustic signal. Manual or automatic triggering of data transfer. Output of predefined reports with headers in 5 languages (plus a programmable one) using an external printer unit (A4 format).



PRESET function for entering a given value. Acoustic signal. Manual or automatic triggering of data transfer. Output of predefined reports with headers in 5 languages (plus a programmable one) using an external printer unit (A4 format).



00760220

Power Panel for MICRO-HITE plus M with printer

0,0001 / 0,001 / 0,01

0.00001 / 0.0001 / 0.001

00760221

Power Panel for MICRO-HITE plus M

0,0001 / 0,001 / 0,01

0.00001 / 0.0001 / 0.001

OPTIONAL ACCESSORIES:

04765008

Thermal paper, 57 mm wide

04761052

Extension cable, Sub-D 9p/f to 9p/m, 2 m

04761063

Sub-D 9p/m to USB cable, 2 m



TESA IG-13 Probe Set for Perpendicularity Measurement



Factory standard



Shipping packaging

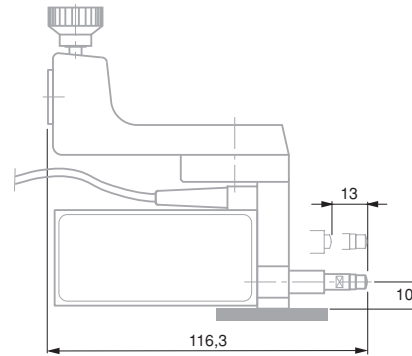

00760140

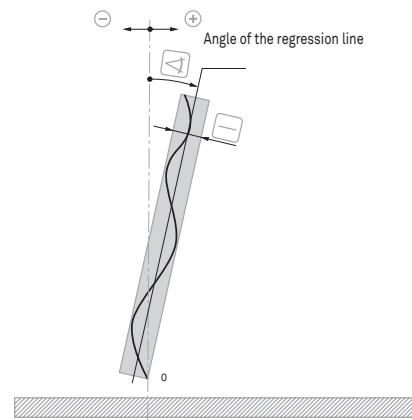
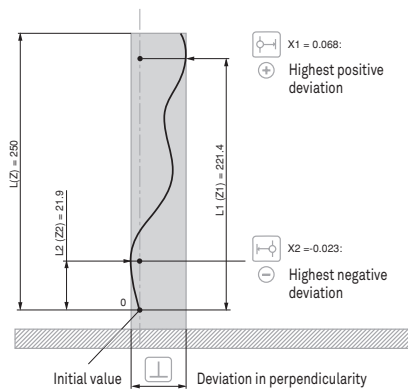

00760140 TESA IG-13 Probe set

CONSISTING OF:

00760138 TESA IG-13 Attachment

00760139 TESA IG-13 Digital probe

OPTIONAL ACCESSORIES:

01960005 Retraction lever

04761047 Connecting cable IG-13/Power Panel plus M 1 m (mini-DIN)



- Factory standard
- 100 mm / 4 in
- 0 to 160 mm 0 to 6.3 in
- 0,001 mm and 0,0001 mm or 0.0001 in and 0.00001 in
- Incremental glass scale with opto-electronic data acquisition. Grating period: 20 µm.
- Error max. tolerated G: see table
- Repeatability limit: see table
- Accuracy class according to DIN 876, Part 1
- finely lapped
- Measuring table (L x P x H) 200 x 300 x 50 mm, Ø column 50 x 300 mm.
- Granite measuring table; dull-chrome plated steel column, hardened and ground.
- 0,63 ± 0,1 N and 1 ± 0,1 N, switchable. Electromotorised activation.
- Numerical interval to 0,001 mm/ 0,0001 in = 10 mm/s; to 0,0001 mm/ 0,00001 in = 5 mm/s; fast displacement = 30 mm/s
- Electro-motorised gauge head displacement; can also be moved manually.
- Via the control panel
- 11,5 x 10⁻⁶ K⁻¹

TESA-µHITE

Compact design with measuring stand included – Sensor equipped with a system for coaxial measuring according to the Abbe principle or using an offset probe relative to the gauge axis. Measures internal, external, height, depth, step and distance dimensions on geometric elements having either a flat, parallel or cylindrical surface – Automatic detection of the culminating point on bores or shafts – Dynamic probing with memory functions "max.", "min." and "max.-min.". The whole system provides the best solution for measuring straightness, flatness and parallelism or inspecting axial and radial runouts depending on the chosen tool configuration.

- Ideal for workpiece inspection close to the production area.
- 100 mm measuring span.
- 0,001 mm and 0,0001 mm or 0.0001 in and 0.00001 in scales intervals.
- Max. perm. error as low as 2 µm (or 1 µm when checking coaxiality).
- Integrated temperature sensor so that the coefficient of linear expansion of each gauge unit matches that of steel (11,5 x 10⁻⁶ K⁻¹).
- Motorised measuring head for fast probing at each point.
- Automatic value capture, controlled over the stability of the measuring force, but also all measured values.
- Constant measuring force through the motor-driven actuator. Switchable.
- No manual calculation needed.
- RS232 data output with direct connection to TESA PRINTER SPC.
- Memory capacity for 99 single values.

Accuracy

Insert's position relative to the axis of the measuring bolt				
	µm	in	µm	in
Coaxial	1,0	0.00005	0,5	0.00002
Offset	2,0	0.0001	1,0	0.00004

Applicable with used standard accessory

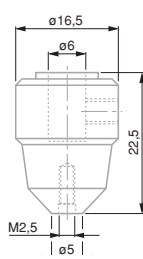
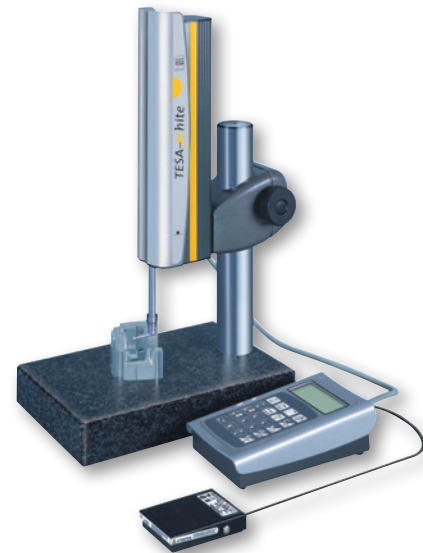

00760195

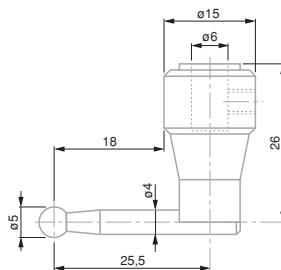

00760197

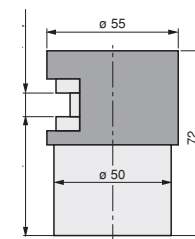

00760192

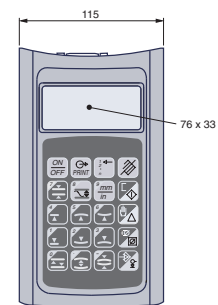

00760204

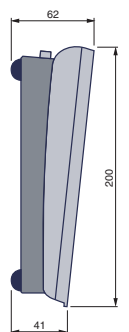

No					
00730049	TESA-µHITE	0 ÷ 160	0 ÷ 6,3	Coaxial tip: 1,0 off-centre tip 2,0	Coaxial tip: 0,5 / 0.00002; off-centre tip 1,0 / 0,00004

CONSISTING OF:

- 00760203 TESA measuring support, granite measuring table, size 200 x 300 x 50 mm
- 00730054 TESA-µHITE electronic measuring equipment

CONSISTING OF:

- 038407 1 plastic case
- 00730050 TESA-µHITE probe
- 00760191 Connecting cable Panel / TESA-µHITE
- 00760192 Master piece for establishing the probe constant, nominal dimension 10 mm / 0.39370 in
- 00760195 Axial insert holder M2,5
- 00760197 Probe insert with a 5 mm dia. tungsten carbide ball tip, offset
- 00760204 Control panel, to be connected to TESA-µHITE
- 03510002 Measuring insert TN10W
- 04761054 Mains adapter 100 ÷ 200 VAC / 50 ÷ 60 Hz
- 04761055 Cable EU for mains adapter
- 04761056 Cable US for mains adapter

OPTIONAL ACCESSORIES:

- 00760186 Set of probe inserts for TESA-µHITE
- 04761052 Extension cable, Sub-D 9p/f to 9p/m, 2 m
- 04761063 Sub-D 9p/m to USB cable, 2 m

- 5°C to 40°C
- 10°C to 60°C
- 80 %, non-condensing
- IP50 (IEC 60529)
- EN 61326-1, Class B
- Net weight 16,2 kg (measuring support No. 00760203), net weight 2,6 kg (TESA-µHITE No. 00730050), net weight 1,45 kg (control panel No. 00760204 with cable No. 00760191)
- Shipping packaging
- Identification number
- Declaration of conformity
- SCS calibration certificate

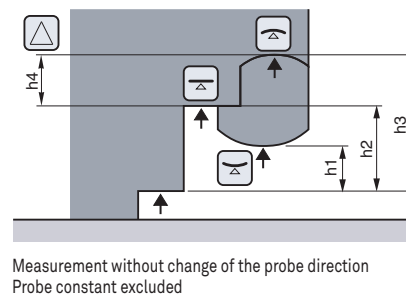
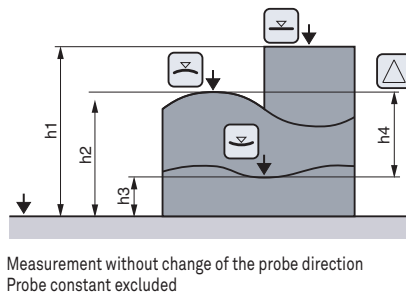

Measurement with change of the probe direction
Probe constant included, considering the culmination point

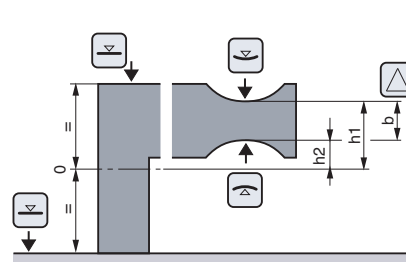
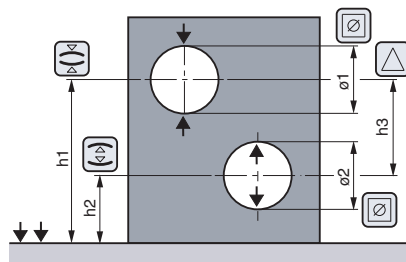

Measurement with change of the probe direction
Probe constant included, disregarding the culmination point

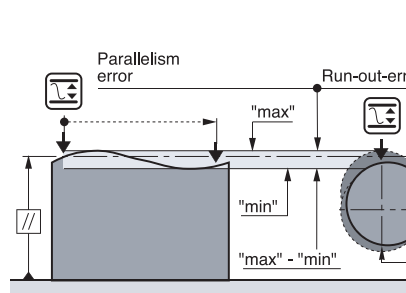
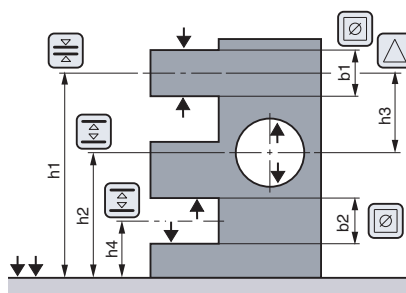



Shipping packaging

Declaration of conformity

Optional Accessories for TESA- μ Hite

No	=
00760194	Axial probe holder for probe inserts with a M1,4 thread
00760196	Axial probe holder for probe inserts with a M3 thread
00760198	Radial probe holder with a 4 mm dia. mounting bore
00760199	Universal probe insert holder with a 4 mm dia. clamping shank (used in conjunction with radial probe holder No. 00760198). M1,4 plus M3 threads (2 x 2) for the probe inserts
00760200	Probe insert with a 5 mm dia. tungsten carbide ball tip. Also with a 4 mm dia. fixing rod for use with radial probe holder insert No. 00760198.
00760201	Probe insert with a 3 mm dia. tungsten carbide ball tip. Also with a 4 mm dia. fixing rod for use with radial probe holder No. 00760198.
00760202	Spare batteries for control panel No. 00760204, 6 Vdc/1,2 Ah.
00760207	Swivel support for control panel

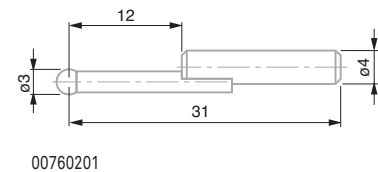
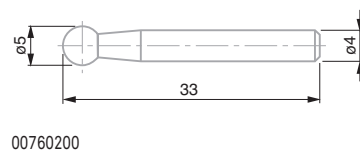
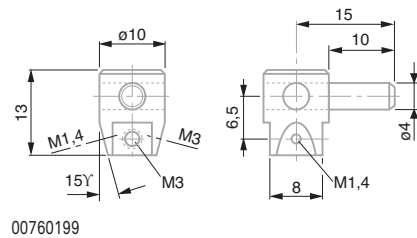
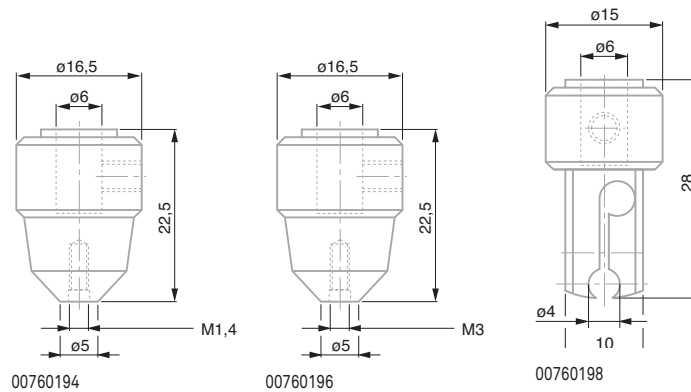

Sets of Accessories for Height Gauges



Shipping packaging



Declaration of conformity



00760232 Starter accessory kit with 4 elements for TESA Height Gauges

CONSISTING OF:

00760061 Probe insert with a 3 mm dia. carbide ball tip

00760075 Probe insert with a carbide disc tip $E = 2 \text{ mm} / \varnothing 14 \text{ mm}$ for grooves, slots, centering shoulders etc.

00760082 2 mm dia. probe insert with a small cyl. carbide face

00760094 Probe inserts with a stainless steel shank, hardened. Also with one flat and one spherical carbide measuring face. Interchangeable shank.

059215 Plastic box

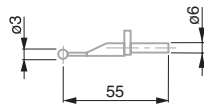

00760061

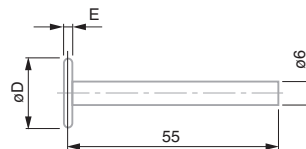

00760075

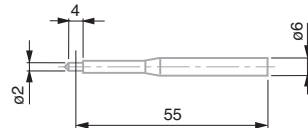

00760082

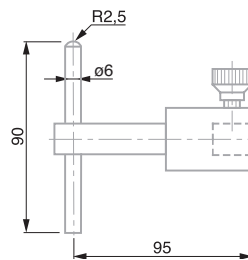

00760094





Shipping packaging



Declaration of conformity

Sets of Accessories for Height Gauges

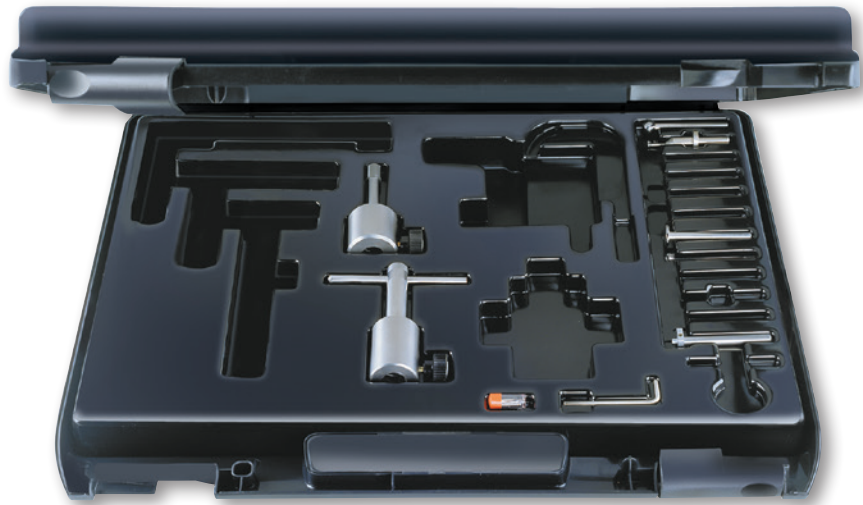

00760173 Starter accessory kit with 8 elements for TESA Height Gauges

CONSISTING OF:

- 00760061** Probe insert with a 3 mm dia. carbide ball tip
- 00760060** Probe insert with a 10 mm dia. carbide ball tip
- 00760075** Probe insert with a carbide disc tip E = 2 mm / Ø 14 mm for grooves, slots, centering shoulders etc.
- 00760093** Probe insert with a cylindrical, tungsten carbide measuring face (10 mm dia., 12 mm long). Stainless steel body, hardened.
- 00760094** Probe inserts with a stainless steel shank, hardened. Also with one flat and one spherical carbide measuring face. Interchangeable shank.
- 00760228** Probe insert dia. 1 mm with shank and ball tip in tungsten carbide
- 00760229** Probe insert dia. 2 mm with shank and ball tip in tungsten carbide
- 00760230** Probe insert dia. 3 mm with shank and ball tip in tungsten carbide

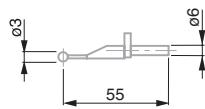

00760061

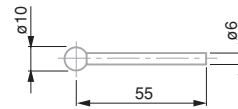

00760060

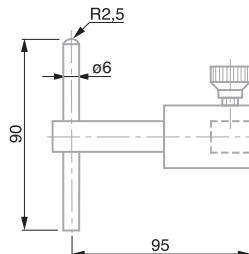

00760094

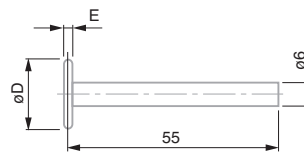

00760075

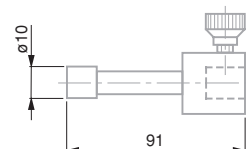

00760093

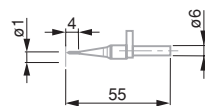

00760228

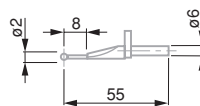

00760229

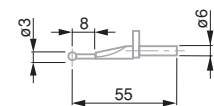

00760230



Sets of Accessories for Height Gauges



Shipping packaging



Declaration of conformity

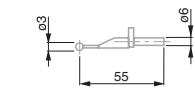

00760061

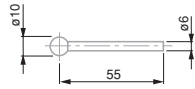

00760060

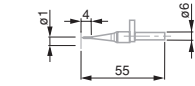

00760228

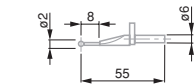

00760229

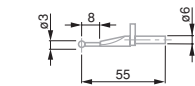

00760230

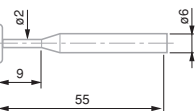

00760074

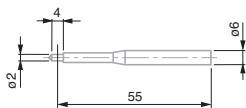

00760082

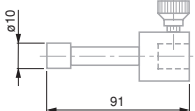

00760093

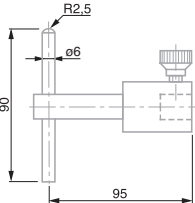

00760094



00760148 Full accessory set with 17 elements for TESA Height Gauges

CONSISTING OF:

- 00760057** Probe insert holder for extending the application range
- 00760060** Probe insert with a 10 mm dia. carbide ball tip
- 00760061** Probe insert with a 3 mm dia. carbide ball tip
- 00760066** Probe insert \varnothing 2,2 mm (for M3 to M16 threads) with carbide, barrel-shaped measuring faces for cylindrical bores as well as for determining the position of metric inside threads (or similar).
- 00760067** Probe insert \varnothing 4,5 mm (for M6 to M48 threads) with carbide, barrel-shaped measuring faces for cylindrical bores as well as for determining the position of metric inside threads (or similar).
- 00760068** Probe insert \varnothing 9,7 mm (for M12 to M150 threads) with carbide, barrel-shaped measuring faces for cylindrical bores as well as for determining the position of metric inside threads (or similar).
- 00760074** Probe insert with a carbide disc tip E = 1 mm / \varnothing 4,5 mm for grooves, slots, centering shoulders etc.
- 00760075** Probe insert with a carbide disc tip E = 2 mm / \varnothing 14 mm for grooves, slots, centering shoulders etc.
- 00760076** Probe insert with a carbide disc tip E = 3 mm / \varnothing 19 mm for grooves, slots, centering shoulders etc.
- 00760082** 2 mm dia. probe insert with a small cyl. carbide face
- 00760086** Probe insert holder for depth up to 110 mm (L = 75 mm)
- 00760087** Probe insert holder for depth up to 185 mm (L = 150 mm)
- 00760094** Probe inserts with a stainless steel shank, hardened. Also with one flat and one spherical carbide measuring face. Interchangeable shank.
- 00760228** Probe insert dia. 1 mm with shank and ball tip in tungsten carbide
- 00760229** Probe insert dia. 2 mm with shank and ball tip in tungsten carbide
- 00760230** Probe insert dia. 3 mm with shank and ball tip in tungsten carbide

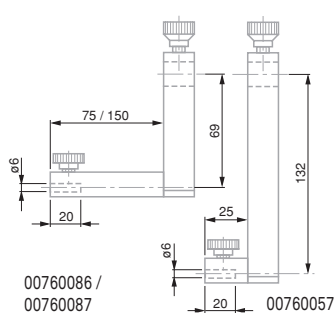

00760086 / 00760087

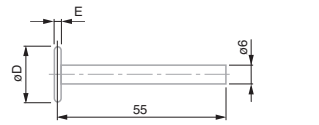

00760076

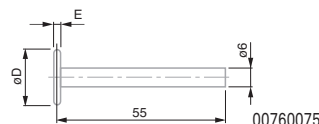

00760075

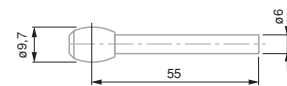

00760068

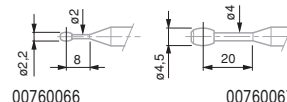

00760066

00760067





Shipping packaging

Declaration of conformity

Sets of Accessories for Height Gauges



00760175 Set of probe inserts for TESA-HITE, TESA-HITE plus M, TESA-HITE magna, MICRO -HITE and MICRO-HITE plus M

CONSISTING OF:

00760177 Probe insert holder

00760178 Hardened steel rod for grooves, centring shoulders, blind bores etc, angled through 8°

00760179 Tungsten carbide cylindrical rod for depth measurement

00760180 Probe inserts with a 0,9 mm dia. hardened steel ball tip

00760181 Probe inserts with a 1,9 mm dia. hardened steel ball tip

00760182 Probe inserts with a 1,9 mm dia. hardened steel ball tip

00760183 Hardened steel probe insert with a cone-shaped measuring face, 8 mm dia.

00760184 Extension, 20 mm, with a M3 thread for inserts with M3 thread

00760185 Extension, 20 mm, with a M3 thread for inserts with M2,5 thread

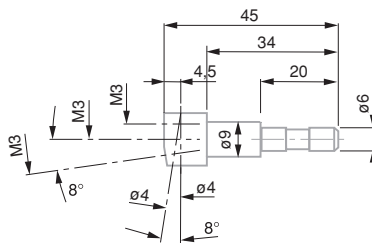

00760177

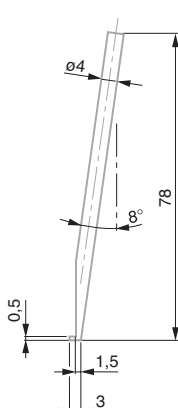

00760178

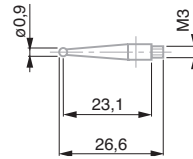

00760180

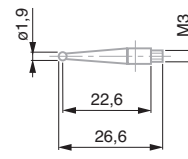

00760181

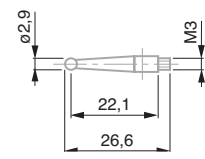

00760182

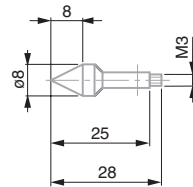

00760183

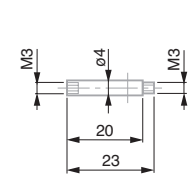

00760184

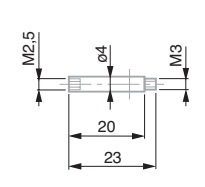

00760185

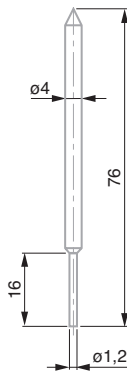

00760179

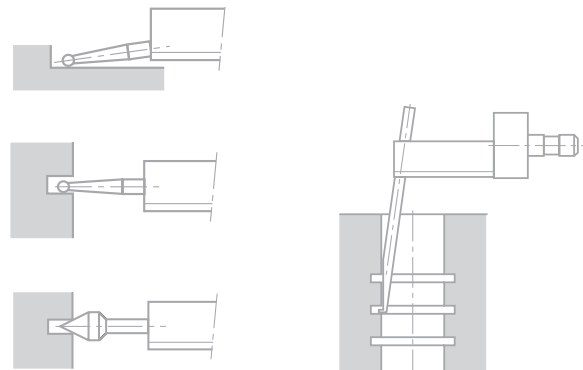

Sets of Accessories for Height Gauges



Shipping packaging



Declaration of conformity



00760186	Set of probe inserts for TESA- μ HITE
<i>CONSISTING OF:</i>	
00760178	Hardened steel rod for grooves, centring shoulders, blind bores etc, angled through 8°
00760179	Tungsten carbide cylindrical rod for depth measurement
00760180	Probe inserts with a 0,9 mm dia. hardened steel ball tip
00760181	Probe inserts with a 1,9 mm dia. hardened steel ball tip
00760182	Probe inserts with a 2,9 mm dia. hardened steel ball tip
00760183	Hardened steel probe insert with a cone-shaped measuring face, 8 mm dia.
00760184	Extension, 20 mm, with a M3 thread for inserts with M3 thread
00760185	Extension, 20 mm, with a M3 thread for inserts with M2,5 thread
00760187	Probe insert holder

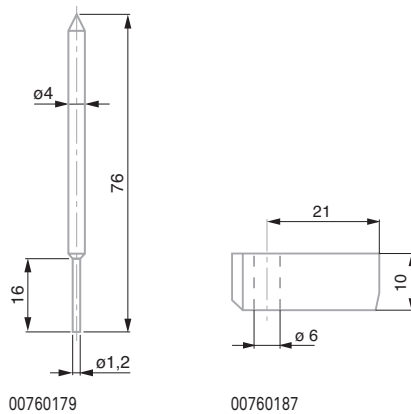
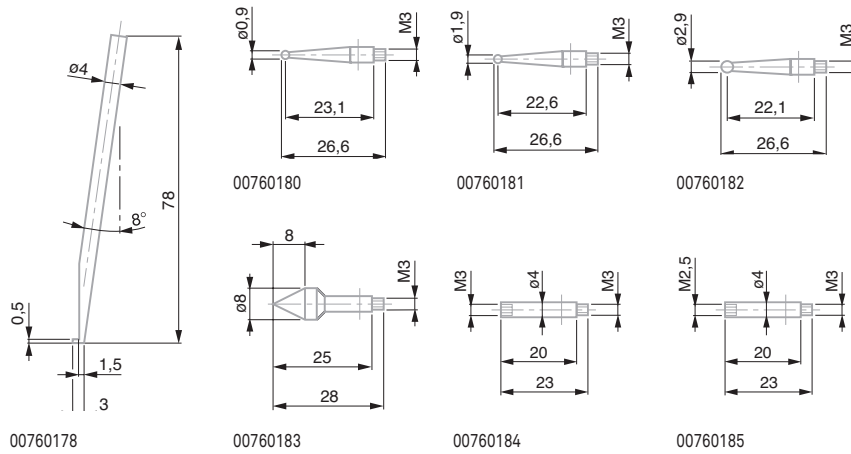

- Factory standard
- Shipping packaging

Probe Holder No. 00760223 for Inserts with 8 mm Diameter



00760223 Probe holder for inserts with 8 mm diameter

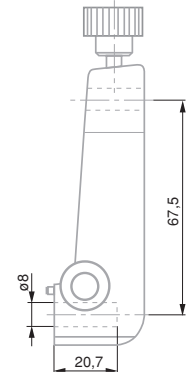

- Factory standard
- Shipping packaging

Optional Accessories for Use with Insert Holder No. 00760223



- 0071684815 Probe insert with a 4 mm dia. tungsten carbide ball tip
- 0071684816 Probe insert with a 6 mm dia. tungsten carbide ball tip
- 0071684817 Long probe insert with a 10 mm dia. tungsten carbide ball tip
- 0071684818 Probe insert with a 1 mm dia. steel tip, hardened. Also with adjustable shank for depth measurement.
- 0071684819 Probe insert with cone-shaped measuring face in hardened steel for $\varnothing 5 \div 20$ mm
- 0071684820 Probe insert with cylindrical measuring face in hardened steel, $\varnothing 10$ mm, 12 mm long
- 0071684822 Probe insert with cone-shaped measuring face in hardened steel, $\varnothing 0,5 \div 5,5$ mm
- 0071684825 Probe insert with a 6 mm dia. tungsten carbide ball tip
- 0071684826 Attachment for interchangeable inserts with M1,4 thread. Supplied with 1 insert No. 01860201 having a 1 mm dia. carbide ball tip.
- 0071684827 Probe insert with disc-shaped face $\varnothing 12$ mm, 3 mm wide
- 0071684828 Attachment for interchangeable insert with M1,4 thread. Supplied with 2 probe inserts No. 0186020 having a 2 mm dia. carbide ball tip
- 0071684829 Probe insert with a 10 mm dia. tungsten carbide ball tip
- 0071684832 Probe insert with a 8 mm dia. tungsten carbide ball tip

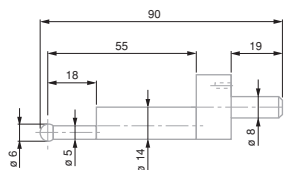
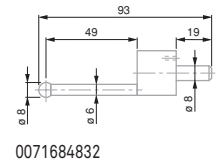
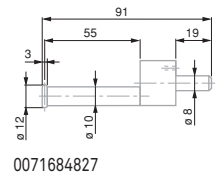
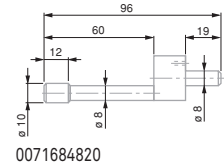

0071684825

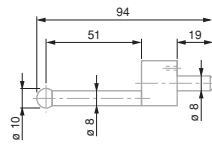

0071684829

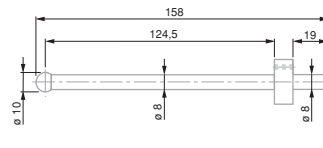

0071684817

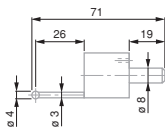

0071684815

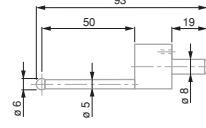

0071684816

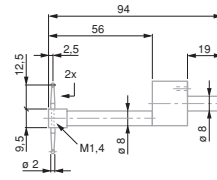

0071684828

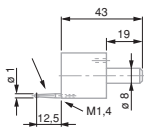

0071684826

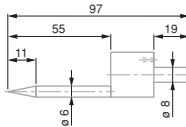

0071684822

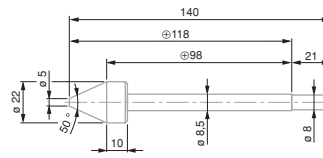

0071684819

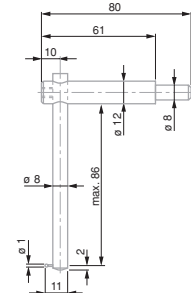

0071684818



Accessories for Measuring Perpendicularity by Means of a Dial Test Indicator

Used with TESA MICRO-HITE plus M, TESA MICRO-HITE, TESA-HITE 400/ 700 and TESA-HITE plus M 400/ 700.

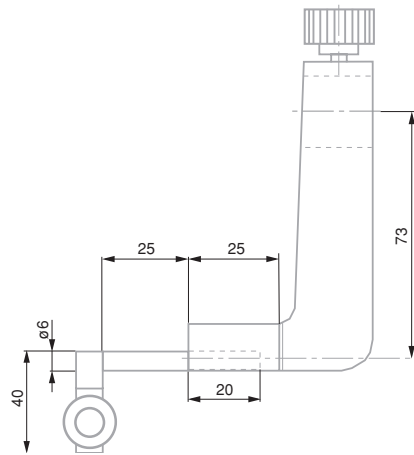

00760222 Probe insert holder for a dial test indicator (lever-type)



- Factory standard
- Floating zero
- DIN 862
For lengths up to
600 mm = 30 µm
1000 mm = 40 µm
- Steel base,
hardened
- Wooden case
- Declaration of
conformity
- Identification
number
- Slider with inter-
changeable scriber.
Also with back
mounted clamping
holder having
a 8 mm diameter.
Slider with locking
screw and fine
adjust device.
Base has a ground
face with dust
grooves. Top face
also ground.
- Preset and Hold
functions



ETALON Height and Scribing Gauges with Digital Display

- Electronic height and scribing gauges
- Resolution to 0,01 mm/0.005 in
 - RS232 interface

No	mm	in	Column, mm	Base (L x H x W) mm
07739001	0 ÷ 300	0 ÷ 12	25 x 6	60 x 40 x 100
07739002	0 ÷ 600	0 ÷ 24	30 x 12	110 x 50 x 160
07739003	0 ÷ 1000	0 ÷ 40	30 x 12	110 x 50 x 160

Accessories for ETALON Height and Scribing Gauges with Digital Display



07769005



07769006

No	=	A	T
		Suitable for models	Length, mm
07769001	Scriber for 300 mm length	65	65
07769003	Scriber for 6 to 1000 mm, length	75	75
07769005	Holder to replace the scriber		
07769006	Rotating and tilting version with a 8 mm dia. shank. To be used with No. 07769005		



